

# Indoor Unit Operation & Installation Manual

AWSI-FAV012-N11

AWSI-FAV018-N11

AWSI-FAV024-N11

No.0150510089

- Please read this manual carefully before using
- Keep this operation manual for future reference

# User Manual

The indoor unit, suspended to ceiling or standing on floor, renders considerable operating ease and flexibility.

With its ultra-thin design, dazzling exterior and space economy, the indoor unit fits in well with indoor scenarios.

Boasting superb power and fast temperature tuning, the indoor unit delivers undeniable comforts and pleasures whenever you feel like wanting the same.

Highly efficient silencing technology greatly reduces operating noises and delivers natural comforts.

In case of sudden blackout during operation, the indoor unit, with its Blackout Retrieval function preset, is capable of retrieving its operating status prior to the blackout when power supply is restored.

Integrated Control is available with the indoor unit (through integrated controller).

Multi-connected unit series features “uniform control mode”, i.e., all indoor units are restricted to run on heating or cooling mode at the same time.

For the protection of compressor, the air conditioning unit shall be powered for over 12 hours.

## Contents

Parts and Functions .....	1-6
Safety Considerations .....	7-9
Operation instruction .....	10-17
Maintenance .....	18
Fault Checkup .....	19
Installation Procedures .....	20-27
Electrical Wiring .....	28-33
Functions of Wired Controller .....	34
Test Run & Fault Code .....	35-36
Disposal .....	37

whole model	brief model
AWSI-FAV012-N11	FAV012
AWSI-FAV018-N11	FAV018
AWSI-FAV024-N11	FAV024

The brief model is used in this manual for above models.

## Operating Range of Air Conditioner

cooling dry	indoor	max.	DB: 32°C	WB: 23°C
		min.	DB: 18°C	WB: 14°C
	outdoor	max.	DB: 43°C	WB: 26°C
		min.	DB: -5°C	
heating	indoor	max.	DB: 27°C	
		min.	DB: 15°C	
	outdoor	max.	DB: 21°C	WB: 15.5°C
		min.	DB: -15°C	

# Parts and Functions

---

## Indoor Unit

Model FAV012, FAV018, FAV024

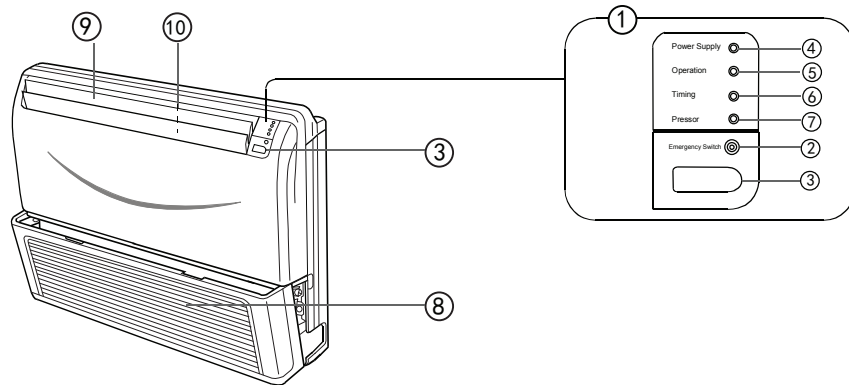

① Control Panel

② Emergency Operation Switch

③ Remote Control Signal Window Receiver

④ Power Indicator

⑤ Operation Indicator

⑥ Timing Indicator

⑦ Pressor Indicator

⑧ Air Inlet

⑨ Outlet Guide Plate

⑩ Outlet Flap

# Parts and Functions

## Wind Direction Regulation

Model FAV012, FAV018, FAV024

### Auto Airflow

Press the Wind Direction button, outlet guide plate changes posture as shown below.

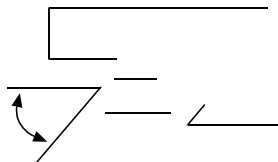

Recommended angles at which swinging guide plate stops

Cooling and Drying	<p>Air Delivery along Horizontal Direction</p>
Heating	<p>Downward Air Delivery</p>

## Fixing Outlet Direction

Decide upon a proper angle when guide plates move in auto airflow mode and press Wind Direction button to fix wind direction.

Upper/lower flaps commanding airflow directions shall be positioned as follow when fixing wind directions:

Upward in cooling and drying mode

Downward in heating mode

- Make sure that outlet plates or flaps are adjusted only and always through the Wind Direction button on remote control; manual adjusting may cause malfunction.
- Outlet guide plates constantly positioned downwards are prohibited when cooling and drying modes are activated as vapor close to outlet grille may condense and resultant water may drip down from the unit.
- Please pay close attention to temperature regulation values when operating the unit in places where infants, children, old people and patients are to be found.

# Parts and Functions

## Buttons of the wire controller

**Fan speed switch**  
Change wind speed

**Mode switch**  
Choose running mode

**Health switch**  
Used to control oxygen function and negative ion

**Swing switch**  
Open and close air flap

**TEMP switch**  
Used for changing set temperature

**Time switch**  
It is used to regulate setting time.

**Clock, timing and address setting**

**Air change switch**  
It is used to open and close air change function. The mode is as follows:  
No display-air change  
(automatic)-air change  
(RECOVERY)-air change  
(NORMAL)

**ON/OFF switch**  
Do on and off function. The unit is on when pressing it; and is off when pressing it again.

**Timing switch**  
It is used for choosing timing running

**Self-inspection switch**  
It is used for inspection service

**Filter reset**  
After cleaning air inlet and filter, press this switch. The unit begins to run

**Reset key**  
When in abnormal state, push the reset key with a spike, which may return the unit to normal

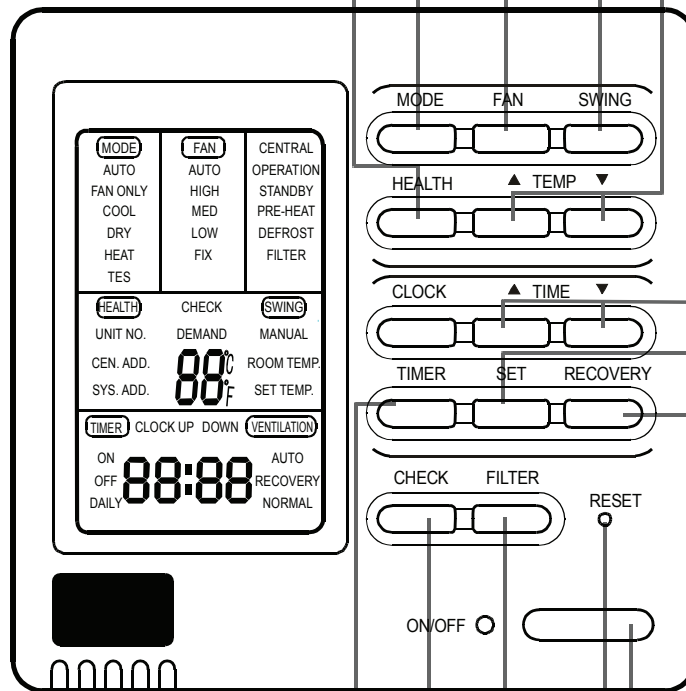

# Parts and Functions

## Display of the wire controller

### Air volume display

Display the setting speed

### Running mode display

Show the selected mode

### Health function display

### Unit number display

### Centralized address display

### System address display

### Temperature display

Display the room temperature, setting temperature, and unit number

### Timing operation display

Show timing operation content

### Inspection status display

### Demand display

When forced to run, "DEMAND" will be displayed, or show HH/LL in the temperature zone.

### Centralized display

When controlled by centralized controller, and chosen by "centralize or lock" mode, this information is shown.

### Running display

When the compressor runs, it displays.

### Standby display

When the unit is on power and in "abnormity mode", or outdoor unit malfunction show alarm, "standby" is shown to reflect no need to unit.

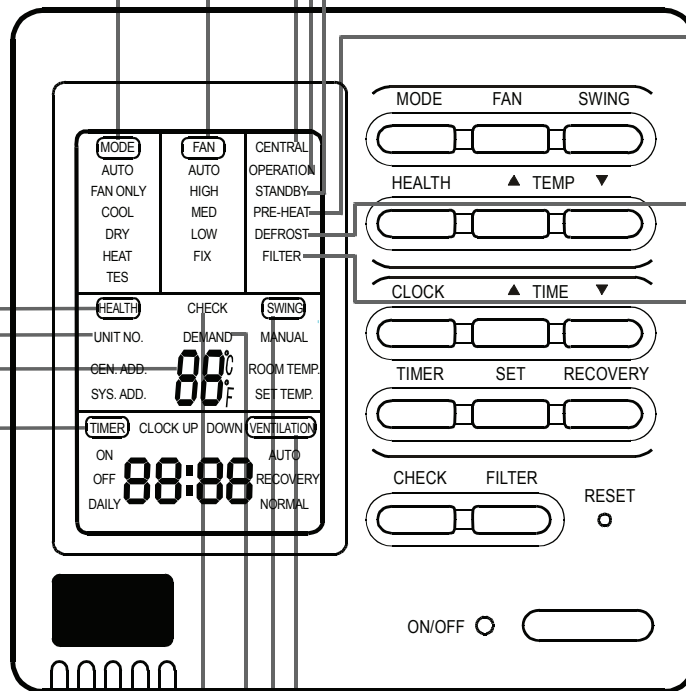

When in preheating status, "preheating" is shown.

"Defrost" is shown when defrosting.

### Filter screen warning sign

When the sign is shown, please clean the filter screen

### Air change display

### Wind swing display

### Remarks

- The models in the manual don't have health, filter reset and Air change function.

# Parts and Functions

## Remote controller

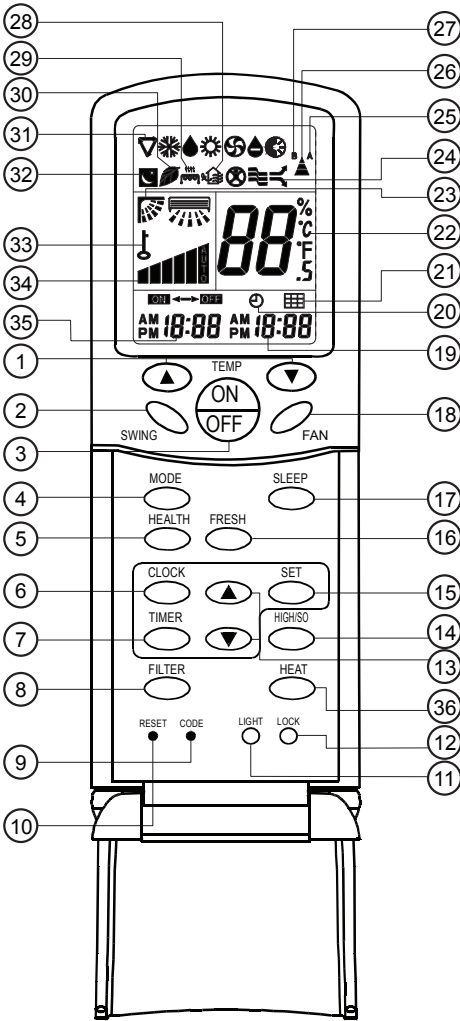

### 1.TEMP Setting Button

Used to set temperature.

The temperature ranges: 16°C~ 30°C.

In Up/Down function of filter, for controlling up and down filter.

### 2.SWING Button

If you press this button once, auto swing will be activated. If you press this button again, the louver will fix in the present position.

### 3.Power ON/OFF Button

Used for unit to start or stop.

After power on, the LCD of remote controller will display the previous operation state (except for TIMER,SLEEP and SWING state).

### 4.Operation MODE Button

Used to select operation mode.

Every time you press MODE button, operation mode changes according to following sequence:

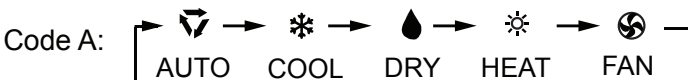

### 5.HEALTH Button

Used to set health operation function.

### 6.CLOCK Button

Used to set correct time.

### 7.TIMER Button

Used to select TIMER mode:TIMER ON,TIMER OFF, TIMER ON-OFF.

(Note: if the time of TIMER ON is the same as TIMER OFF, TIMER ON-OFF cannot be set)

### 8. FILTER Button

Used to set up/down function of filter.

### 9.CODE Button

Used to select Code A or B, Normally at Code A. As you can't control the indoor unit, please change the Code to B.

### 10.RESET Button

Press this button by using a sharp article to resume the correct operation of the remote controller in case of need, for example, in case of malfunctions due to electromagnetic disturbance.

### 11.LIGHT Button

Used to light the control panel

### 12.LOCK Button

Used to lock operation button and LCD display contents. If you press this button, the other buttons come out of function and lock state display appears; if you press it again, lock state will be no more active and lock state display will disappear.

### 13.HOUR Adjustment Button

Used to set clock and timer setting

### 14.HIGH/SO Button

Used to select HIGH or SOFT operation.

### 15.SET Button

Used to confirm TIMER and CLOCK settings.

### 16.FRESH Button

Used to set fresh mode, the unit will draw in fresh air.

### 17.SLEEP Button

Used to set sleep mode. (The clock must be corrected before setting sleep function)

### 18.FAN Button

Used to select fan speed:LOW,MID,HIGH,AUTO.

### 19.TIME Display

### 20.TIMER Display

### 21.FILTER Display

When the filter need be cleaned, you can press the FILTER button for 3s, to up/down function.

### 22.TEMPERATURE Display

### 23.AUTO SWING Display

# Parts and Functions

## 24.HIGN/SO Run Display

## 25.Code A of controller's state

Code A is used for the units in this manual.

## 26.SIGNAL SENDING Display

## 27.Code B of controller's state

## 28.Fresh Display

## 29.Auxiliary ELECTRICAL HEATING Display

## 30.HEALTH Display

Displays when healthy run function is set.

## 31.Operation MODE Display

AUTO RUN	COOL RUN	DRY RUN	HEAT RUN	FAN RUN
▽	☀	💧	☀	⚙

## 32.SLEEP State Display

## 33.LOCK State Display

## 34.FAN SPEED Display

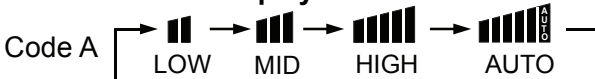

## 35.TIMER ON Display

## 36.HEAT Button

Used to select auxiliary heater function.

### Note:

1.Models in this manual have no functions

⑤ ⑧ ⑪ ⑭ ⑯ ⑰ ⑲ ⑳ ㉓ ㉔ ㉕ ㉖ ㉗ ㉘ ㉙ ㉚ ㉛ ㉜

2.HIGH/SO button

This button is active in Cooling/Heating mode, the fan speed is in AUTO mode after pressing it and "high function" will be automatically cancelled after 15 minutes running.

## Remote Controller Operation

- When in use, direct signal transmission head to the receiver placed on the indoor unit.
- The distance between the remote controller and the receiver should be max 7m and there should be no obstacle between them.
- Do not throw the remote controller to prevent it from being damaged.

- When operating the remote controller in an area where electronically controlled lights are installed or wireless handsets are used, please move closer to the indoor unit as the function of the remote controller might be affected by signals emitted by the above mentioned equipments.

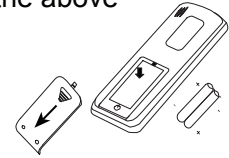

## Battery loading

Batteries are fitted as follows:

### Remove the battery compartment lid

Slightly press and disengage the battery compartment lid marked with "▽" and then hold the remote controller by the upper section and then remove the battery compartment lid by pressing in the direction of the arrow as shown in the figure above.

### Loading the battery

Ensure that batteries are correctly placed in the compartment as required for positive and negative terminals.

### Replacing the battery compartment lid

The battery compartment lid is reinstalled in the reverse sequence.

### Display review

Press the button to see if batteries are properly fitted.

If no display appears, refit the batteries.

### Confirming indicator

If no indication is displayed after press ON/OFF button, reload the batteries.

**Caution:** if the remote controller does not operate as designed after fitting new batteries of the same type, press the Reset button (marked ↓) with a pointed article.

### Note:

It is recommended that the batteries should be removed from the compartment if the remote controller is not used for an extended period.

The remote controller is programmed for automatic test of operation mode after the batteries are replaced. When the test is conducted, all icons will appear on the screen and then disappear if the batteries are properly fitted. When throw away the waste batteries, please perform in accordance with the local regulation.

## Clock Set

When the unit is started for the first time or after replacing batteries in remote controller, clock should be adjusted as follows:

- 1.Press CLOCK button, clock indication of " AM " or " PM " flashes.
- 2.Press " ▲ " or " ▼ " to set correct time. Each press the time will increase or decrease by 1 min. If the button is kept pressed, the time will increase or decrease quickly.
- 3.Press "SET" button to confirm the time setting. AM or PM stop flashing, while clock starts working.



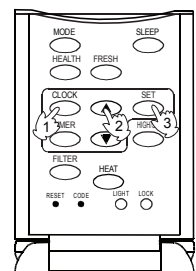

Note:AM means morning and PM means afternoon.





# Safety Considerations

---

- If the air conditioner is transferred to a new user, this manual shall be transferred to the user, together with the conditioner.
- Before installation, be sure to read Safety Considerations in this manual for proper installation.
- The safety considerations stated below is divided into “ Warning” and “ Attention”. The matters on severe accidents caused from wrong installation, which is likely to lead to death or serious injury, are listed in “ Warning”. However, the matters listed in “ Attention” are also likely cause the severe accidents. In general, both of them are the important items related to the security, which should be strictly abided by.
- After the installation, perform test run to make sure everything is in normal conditions, and then operate and maintain the air conditioner in accordance with the User Manual. The User Manual should be delivered to the user for proper keeping.



## Warning

- Please ask the special maintenance station for installation and repair. Water leakage, electric shocks or fire accidents might be caused from improper installation if you conduct the installation by your own.
- The installation should be conducted properly according to this manual. Water leakage, electric shocks or fire accidents might be caused from improper installation.  
Please make sure to install the air conditioner on the place where can bear the weight of the air conditioner.
- The air conditioner can't be installed on the grids such as the non-special metal burglar-proof net. The place with insufficient support strength might cause the dropdown of the machine, which may lead to personal injuries.
- The installation should be ensured against typhoons and earthquakes, etc. The installation unconformable to the requirements will lead to accidents due to the turnover of the machine.
- Specific cables should be used for reliable connections of the wirings. Please fix the terminal connections reliably to avoid the outside force applied on the cables from being impressed on the cables. Improper connections and fixings might lead to such accidents as heating or fire accidents.
- Correct shapes of wirings should be kept while the embossed shape is not allowed. The wirings should be reliably connected to avoid the cover and the plate of the electrical cabinet lipping the wiring. Improper installation might cause such accidents as heating or fire accidents.
- While placing or reinstalling the air conditioner, except the specific refrigerant (R410A), don't let the air go into the refrigeration cycle system. The air in the refrigeration cycle system might lead to the cracking or personal injuries due to abnormal high pressure of the refrigeration cycle system.
- During installation, please use the accompanied spare parts or specific parts. If not, water leakage, electric shocks, fire accidents or refrigerant leakage might be caused.
- Don't drain the water from the drainpipe to the waterspout where may exist harmful gases such as sulfured gas to avoid the harmful gases entering into the room.
- During installation, if refrigerant leakage occurs, ventilation measures should be taken, for the refrigerant gas might generate harmful gases upon contacting the flame.
- After installation, check if any refrigerant leakage exists. If the refrigerant gas leaks in the room, such things as air blowing heaters and stoves, etc. may generate harmful gases.
- Don't install the air conditioner at the places where the flammable gases may leak. In case the gas leakage occurs around the machine, such accidents as fire disasters may be caused.
- The drainpipe should be properly mounted according to this manual as to ensure the smooth drainage. In addition, heat preservation should be taken to avoid condensation. Improper drainpipe mounting might cause water leakage, which will get the articles at home wet.
- The refrigerant gas pipe and liquid pipe should be heat insulated to preserve heat. For inappropriate heat insulation, the water caused from the condensation will drop to get the article at home wet.

## Attention

- The air conditioner should be effectively grounded. Electric shocks may occur if the air conditioner is ungrounded or inappropriately grounded. The wire for earthing shouldn't be connected to the connections on the gas pipe, water pipe, lightning rod or telephone.
- The breaker for electricity leakage should be mounted. If not, accidents such as electric shocks may happen.
- The installed air conditioner should be checked for electricity leakage by being powered.
- If the ambient humidity bigger than 80%, when the water discharge hole be blocked or the filter becomes dirty, or airflow speed change, there maybe leads to condensing water drop down, and at the same time there maybe some drops of water spit out.

# Safety Considerations

	<p>Items with this warning sign concerning the product's safety and the personal security must be performed strictly.</p>
	<p>Items with this forbidding sign refer to absolutely forbidden behaviors. If not, they may cause machine damage or endanger operator's personal safety.</p>

Clean the filter regularly.  
Cooling or heating performance will be degraded if the filter is blocked, resulting in large power consumption, failure, and water dripping at freezing.

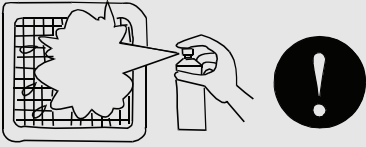

Don't touch the outlet while the flap is moving. Don't put anything in the grid in case danger may occur.

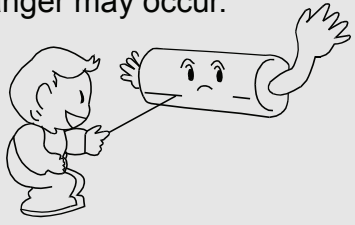

Avoid cold wind from blowing out.  
During heating running, the fan of indoor units will not rotate immediately as to prevent cold wind from blowing out.

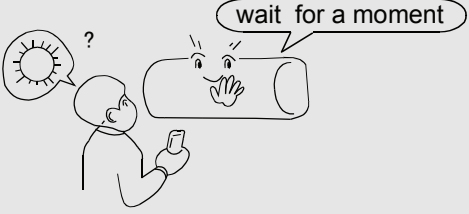

Changing Wind Speeds:  
In the state of refrigerating, with automatic blowing mode, the wind speed automatically decreases when the room temperature approaches the setting.  
In the state of heating, when the room temperature reaches the setting temperature the compressor stops working and the fan turns to low wind or stops. Wind speed changes automatically in the dehumidifying mode.

Regulating Wind Direction:  
It is recommended not to make the wind deflector downwards for a long time to avoid condensation at air outlet port during refrigerating or dehumidifying.  
Water dropping might appear at the air outlet port in refrigerating or dehumidifying mode.

Defrosting:  
During heating running, the air conditioner would defrost automatically if there is frost on heat exchanger of outdoor units.  
Do not rotate fans of both indoor units and outdoor units during defrosting.  
After finishing defrosting, the air conditioner will resume running automatically.

The machine operation must be controlled by the control.



Hints:  
As air conditioners absorb heat from the environment and release it to the room, heating effects will be influenced by the temperature in and out of the room.

# Safety Considerations



Attention

Notices during Operation

- It is not allowed to put any heating apparatus under the indoor units, for the heat may cause distortion of the units.

- Pay attention to the aeration condition to avoid anoxic symptom.



- Flammable apparatus should not be placed in the place where the air conditioner wind could reach directly, or incomplete burning of the apparatus may be caused.



- Check the mount table of the air conditioner for damage for a long period of operation. If placed on the damaged table, the unit may drop down causing damage.



- Plants and animals should not be put to the place where wind of the air conditioner blows directly, otherwise damage to them may be caused.



- It cannot be used for the preservation of food, living creature, precise instrument and artworks, etc, otherwise damage may occur.



- Use the fuse with proper capacity. Metal wires and copper wires, etc., may cause fire or other faults.



- Do not use water heater or like next to the indoor unit and the wired controller. Water/power leakage or short circuit may happen if the steam generating apparatus is working next to machine.



- Defrosting during heating  
To improve the heating effect, the outdoor unit will perform defrosting automatically when frost appears on the outdoor unit during heating (approximately 2-10 min). During defrosting, the fan of the indoor unit runs at a low speed or stops while that of the outdoor unit stops running.

- Power should be cut off when the air conditioner is left unused for a long period. Power will be consumed if the air conditioner is not powered off. The power switch of the outdoor unit switch should be powered on 12 hours in advance before operation to protect the unit after a long period of storage.

- 3-minute protection

To protect the unit, compressor can be actuated with at least 3-minute delay after stopping.

- Close the window to avoid outdoor air getting in.

Curtains or window shutters can be put down to avoid the sunshine.



- Do not touch the switch with the wet hand to avoid power shock.



- Stop running and switch off the manual power switch when cleaning the unit.



- During the operation of the control unit, don't switch off the manual power switch and the controller can be used. Please do not press the liquid crystal zone of controller to prevent damage



- Cleaning the unit with water may cause electric shock.



- Do not put flammable spray close to the air conditioner.

Don't inject flammable spray towards the air conditioner, which may cause fire.



- Stopping fan rotation

The unit which stops operating will actuate the fan for a 2-8 min swing every 30-60 minutes for protecting the unit while other indoor unit are in the operating state.

- This appliance is not intended for use by persons (including children) with reduced physical, sensory or mental capabilities, or lack of experience and knowledge, unless they have been given supervision or instruction concerning use of the appliance by a person responsible for their safety.

- Children should be supervised to ensure that they do not play with the appliance.

# Operation instruction

## ON/OFF operation

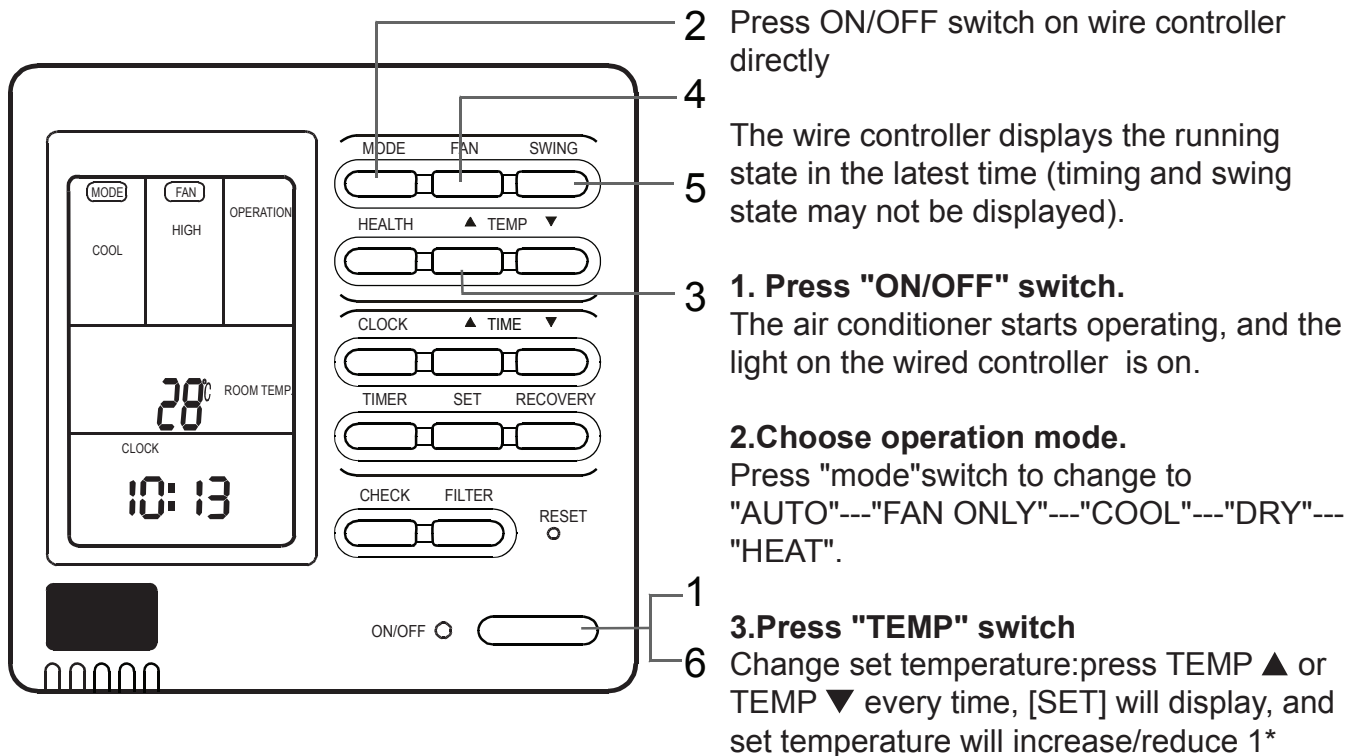

### **4. Press "FAN SPEED" switch**

FAN ONLY Operation:

Press "FAN SPEED" switch to change to "HIGH"--"MED"--"LOW"--"HIGH"

In AUTO, COOL, DRY, HEAT Operation:

Press "FAN SPEED" switch to change to "AUTO"--"HIGH"--"MED"--"LOW"--"AUTO"

### **5. Press "SWING" switch on the wire controller to swing the wind screen.**

### **6. Press "ON/OFF" switch, off.**

The light on the wire controller is off.

## Note

Several seconds after the operation of the wire controller, the setting of the unit will change.

## Remarks

- Avoid pressing "ON/OFF" switch frequently.  
Do not press wire controller or switches by sharp objects.
- The temperature is on the basis of the setting value. The wind temperature may not reach the setting value because of the outer air conditioner and system protection.
- When the wired controller is power on, the screen fully displays it for two seconds. and clock
- zone "8888"- "888"- "88"- "8" flicker for 30 seconds. All the switches are invalid at the time.

# Operation instruction

## Present time setting

- The timing is based on the real time. Thus, the real time should be regulated in advance.
- The clock regulation steps are as follows:

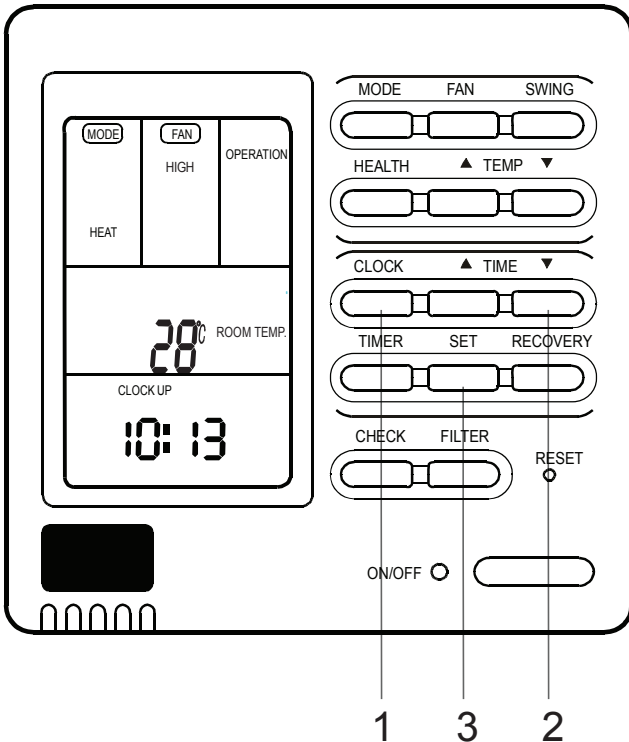

### 1.Press "CLOCK" switch

"CLOCK" flickers, and the time displayed is the real time.

### 2.Press TIME "▲" and TIME "▼" to regulate the time.

The time increases a minute each time you press TIME "▲" switch.

The time decreases a minute each time you press TIME "▼" switch.

### 3.Press "SET" switch. The setting is achieved.

## Note

- If not in timing, the screen displays the real time.
- If in timing, the screen displays the timing time.
- If you want to know the real time, go to the first step.

### Setting of power failure compensation function

When SW1-6 on PCB of wire controller is OFF, it will be in power failure compensation. If the SW1-6 is ON, it has no compensation function.

When the power is on after blackout, the unit will return to the former state if compensation function is set. Otherwise, it will stop. When restarting the unit, press "ON/OFF" switch on wired controller.

# Operation instruction

## Timing setting

- OFF timing: when a set time has elapsed, the unit stops running.
- ON timing: when a set time has elapsed, the unit starts.

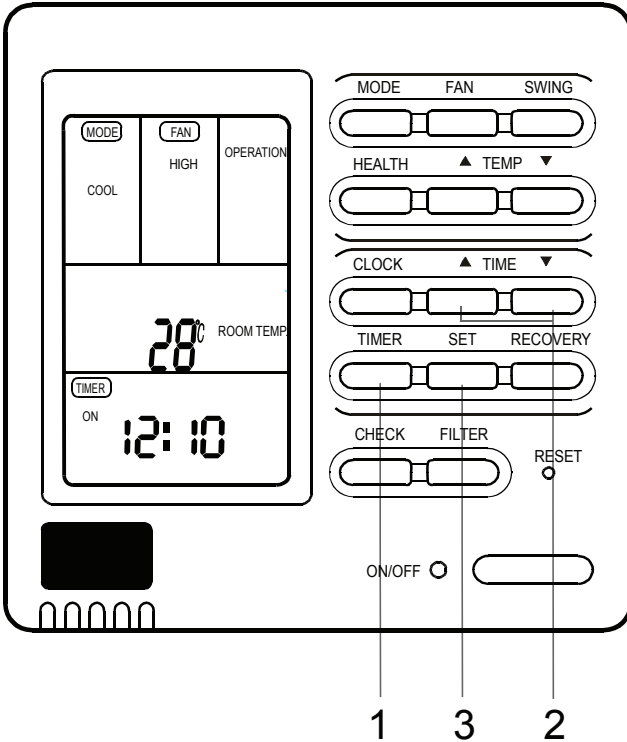

Press "ON/OFF" switch firstly, and set up operation mode. Please regulate the clock in advance before using the timing function.

### 1.Press "TIME" switch.

The display changes with the following sequence:



### 2.Set up "TIMER"

When timing ON or timing OFF flickers, press "▲" or "▼" to regulate the time. Press "▲" or "▼" set up ON/OFF time. The setting time increases ten minutes each time you press "▲" switch. The setting time decreases ten minutes each time you press "▼" switch. When setting timing ON and timing OFF at the same time, press "timing" switch to change the setting item.

### 3.Time setting is achieved.

Press "SET" switch.

### Cancel timing

If you want to change the timing mode to normal operation, press "timing" until there is no timing display. When the timing is invalid, the mode is in normal operation.

## parts of wired controller explanation :

- 1.The unit starts or stops at the setting time. Meanwhile, it displays the timing time.
- 2."ON Timing, OFF timing and circulation" means that the unit is on and off at the setting time everyday.

## Note

- The shorter setting time will be carried out firstly.
- If the ON timing and OFF timing are the same, the setting is invalid.
- Even in timing condition, you may start or close the unit through pressing "ON/OFF" switch.



# Operation instruction

---

## Query indoor malfunction history:

In the state of power on or power off, press [CHECK] button, enter the malfunction-querying mode of all indoor units in the group. Then [CHECK] and [UNIT NO.] will display, and the actual indoor numbers will be displayed in some sequence (unit number is in decimals). At the same time, in the time region, there will be the current malfunction and the latest time malfunction, the displaying format is [XX:YY], in which XX stands for the current malfunction, if normal, it will display "--"; YY stands for the latest time malfunction. The failure code of every unit will display for 3 seconds. After the failure codes of all indoor units in the whole group are displayed, the mode will quit automatically.

## How to change the function switches?

No.	Type	State of switch	Function description
SW1-1	Select the master or the slave controller	ON	set as the slave controller
		OFF	set as the master controller
SW1-2	Select the controller mode	ON	standard controller
		OFF	air handler controller
SW1-3	Room temperature display option	ON	visible room temperature
		OFF	invisible room temperature
SW1-4	26° lock	ON	Unavailable 26° lock
		OFF	available 26° lock
SW1-5	Temperature sensor position option	ON	Sensor of the controller
		OFF	Sensor in the unit
SW1-6	Auto restart	ON	unavailable
SW1-7	Factory Setting	OFF	available
		ON	default setting
SW1-8	Factory Setting	OFF	default setting

## Note

1. Switches or jumper wire must be adjusted when the wire controller is powered off. If the wire controller is powered on, the above operations will be invalid.
2. Function difference between master wire controller and slave one:

Contrastive items	Master wire controller	Slave wire controller
Function	All of functions	Only with below functions: ON/OFF, MODE, FAN SPEED, SET TEMP., SWING

# Operation instruction

## AUTO, COOL, HEAT and DRY Operation

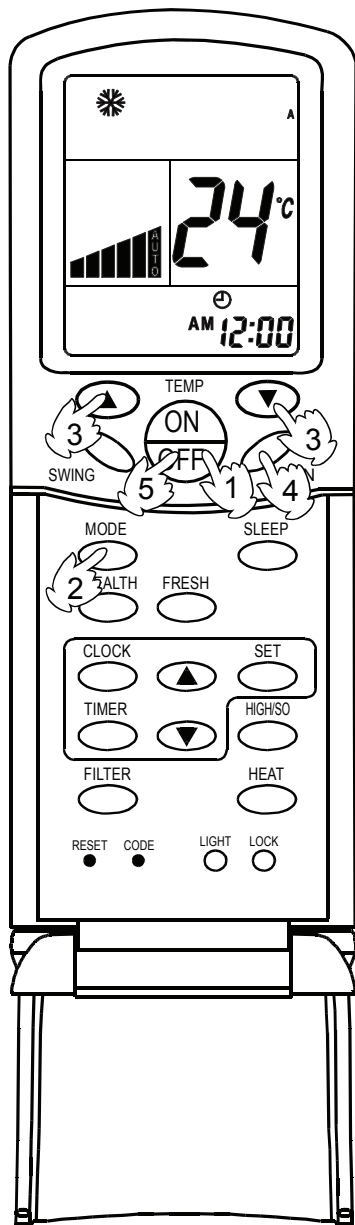

### (1) Unit start

Press ON/OFF button, the unit starts.

Previous operation status appears on LCD (except for TIMER, SLEEP and SWING setting)

### (2) Select operation mode

Press MODE button. Each press, the operation mode changes as follows:

Code A

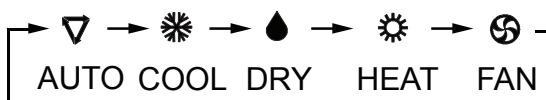

Then select AUTO, COOL, DRY or HEAT as needed.

### (3) Temperature setting

Press TEMP button.

▲ Every time the button is pressed, the setting temperature increases by 1°C; if the button is kept pressed, the setting temperature will increase quickly.

▼ Every time the button is pressed, the setting temperature decreases by 1°C, if the button is kept pressed, the setting temperature will decrease quickly.

Set the proper temperature.

### (4) Adjust fan speed

Press FAN button. Each press, the fan speed changes as follows:

Code A



Air conditioner will run at the selected fan speed.

### (5) Unit stop

Press ON/OFF button, the unit stops.

### NOTE:

- In FAN mode, the temperature setting is not displayed on LCD.
- In DRY mode, when room temperature becomes 2°C higher than temperature setting, unit will run intermittently at LOW speed regardless of FAN setting. When room temperature is lower than temperature setting, unit will only run FAN operation.
- In HEAT mode, warm air will blow out after a short period of time due to cold-draft prevention function.

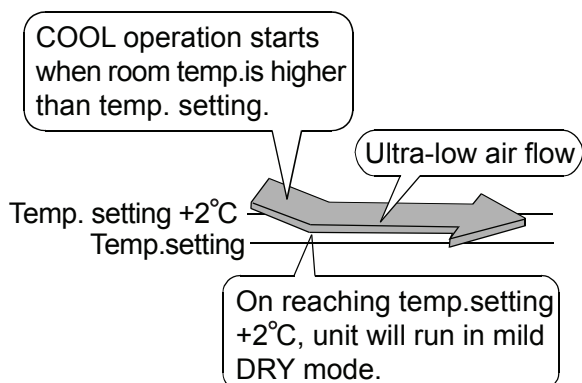



# Operation instruction

## Fan Operation (Only for Code A)

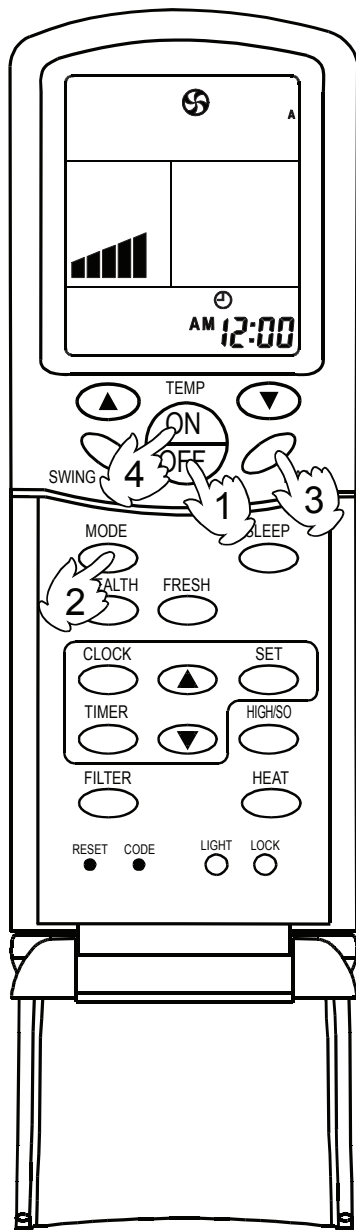

### (1) Unit start

Press ON/OFF button to start your air conditioner.  
Previous operation status appears on LCD (except for TIMER, SLEEP, and SWING setting).

### (2) Select operation mode

Press MODE button. Each press, the operation mode changes as follows:

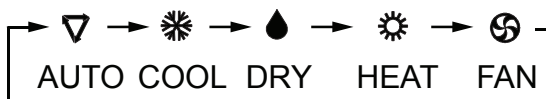

Then select FAN mode.

### (3) Adjust fan speed

Press FAN button. Each press, the fan speed changes as follows:



Air conditioner will run at the selected fan speed.  
When in AUTO mode, the unit will adjust fan speed according to room temperature automatically.

### (4) Unit stop

Press ON/OFF button to stop unit.

### About FAN mode

When the air conditioner runs in FAN mode, it is not possible to select AUTO FAN or to set temperature.

# Operation instruction

## Adjusting Air Flow Directon

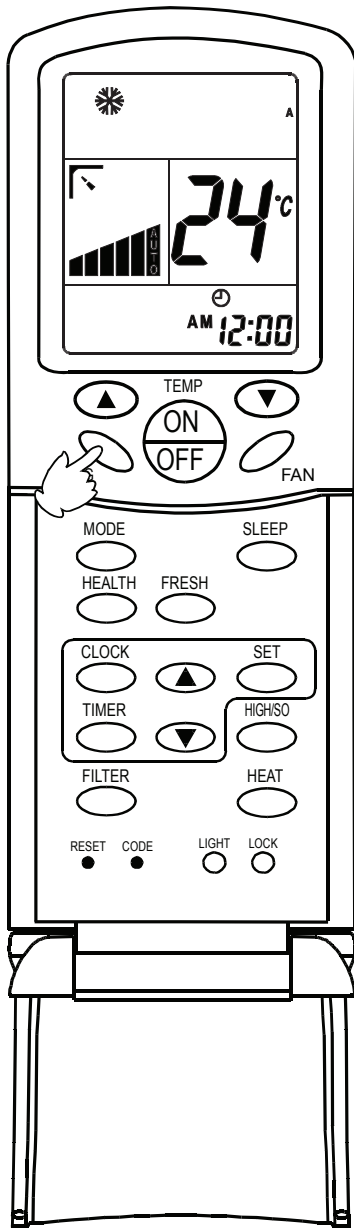

### Adjusting air flow direction

Press SWING button.

Up and down airflow varies upwards and downwards.

Left and right airflow varies left and right sides.

When the automatic swing louver moves to the proper angle, press SWING button to fix the airflow direction.

### After unit stops:

Displays on the LCD disappear.

All indicators on the indoor unit go out.

Swing louver automatically close the air outlet.

### Warning

- Always use SWING button on the remote controller to adjust flaps. Adjusting them by hand may result in air conditioner's abnormally running. If the louver work abnormally, stop unit, restart and adjust the louver by remote controller.
- In COOL or DRY mode, do not leave the louver in downward position for a long time, as the water vapor close to the grille may condense and water may drop from the air conditioner.
- Please carefully set temperature when children, old or infirm people use the air conditioner.
- In case of great humidity, if the vertical flaps are completely turned towards left or right, the louver will drop water.

### Hints:

- As in COOL mode air flows downwards, adjusting airflow horizontally will be much more helpful for a better air circulation
- As in HEAT mode air flows upwards, adjusting airflow downward will be much more helpful for a better air circulation.
- Be careful not to catch a cold when cold air blows downward directly.

# Operation instruction

## Timer ON/OFF Function

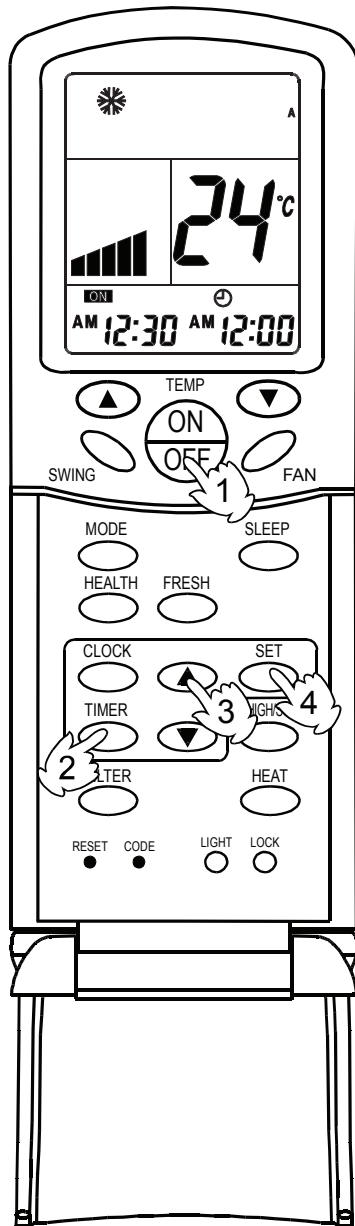

Set clock correctly before starting TIMER operation.

### (1) Unit start

After unit start, select your desired operation mode (operation mode will be displayed on LCD).

### (2) TIMER mode selection

Press TIMER button on the remote controller to change TIMER mode. Every time the button is pressed, display of TIMER mode changes as follows:



Then select TIMER mode as needed (TIMER ON or TIMER OFF). Now **ON** or **OFF** will flash.

### (3) TIMER setting

#### Press time adjustment buttons

- ▲ Every time the button is pressed, the time increases by 10 minutes.
- ▼ Every time the button is pressed, the time decreases by 10 minutes.

If the button is kept pressed, the time will change quickly.

It can be adjusted within 24 hours at will.

### (4) Confirm setting

After setting correct time, press SET button to confirm time. Now **ON** or **OFF** stop flashing.

Time displayed: unit starts or stops at X hour X min (TIMER ON or TIMER OFF)

### (5) Cancel TIMER mode

Just press TIMER button several times until TIMER mode disappears.

### Hints:

- After replacing batteries or if a power failure occurs, TIMER setting must be reset.
- Remote controller has memory function. When you use TIMER mode next time, just press SET button after mode selection if timer setting is the same as the previous one.

# Maintenance

※Only when the air cleaner is switched off and disconnected to the power supply can it be cleaned, or electric shock and injury may appear.

## Cleaning the air outlet port and the shell:

⚠ Attention

- Don't use gasoline, benzene, diluents, polishing powder or liquid insecticide to clean them.
- Do not clean them with hot water of above 50\* to avoid fading or distorting.
- Wipe them with soft dry cloth.
- Water or neutral dry cleanser is recommended if the dust cannot be removed.
- The Wind Deflector can be dismantled to clean (as below).

## Cleaning Wind Deflector:

- Do not wipe the wind deflector with water forcibly to avoid falling off.

## Cleaning Air Cleaner:

⚠ Attention

- Don't rinse the air cleaner with hot water of above 50\* to avoid fading and distorting.
- Don't put the air cleaner on the fire to dry to avoid catching fire.

- Pull the air screen forward to the front side of the unit to remove it.
- Clean up air screens according to their different types. For more information, please make contact with after service staff.



- Wipe dust with water or dust collector.

(A) Wipe dust with dust collector.



(B) Clean it with soft brush in mild detergent if there is too much dust on it



(C) Throw off the water and airing it in the cool dry condition.

## Maintenance before and after Operating Season

Before Operating Season:

1. Please make the following checkup. If abnormal condition occurs, consult the after-service personnel.
  - There is no blockage in inlet port and outlet port of outdoor and indoor units.
  - The ground line and the wiring are in the proper state
2. After cleaning, the air cleaner must be mounted.
3. Switch on to the power.

After Operating Season:

1. In sunny days, blowing operation can be performed for half a day to make the inside of machine dry.
2. Electrical power should be cut down to economize electricity, or the machine will still consume power. Air cleaner and shell must be mounted after cleaning.

# Fault Checkup

Please check the following when consigning repair service:

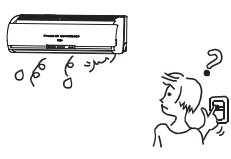
	Symptoms	Reasons
All these are not problems	<ul style="list-style-type: none"> <li>• Water flow sound</li> </ul>	Water flow sound can be heard when starting operation, during operation or immediately after stopping operation. When it starts to work for 2-3 minutes, the sound may become louder, which is the flowing sound of refrigerant or the draining sound of condensed water.
	<ul style="list-style-type: none"> <li>• Cracking sound</li> </ul>	During operation, the air conditioner may make the cracking sound, which is caused from the temperature changes or the slight dilation of heat exchanger.
	<ul style="list-style-type: none"> <li>• Terrible smell in outlet air</li> </ul>	The terrible smell, caused from walls, carpet, furniture, clothing, cigarette and cosmetics, attaches on the conditioner.
	<ul style="list-style-type: none"> <li>• Flashing operating indicator</li> </ul>	When switching it on again after power failure, turn on the manual power switch and the operating indicator flashes.
	<ul style="list-style-type: none"> <li>• Awaiting indication</li> </ul>	It displays the awaiting indication as it fails to perform refrigerating operation while other indoor units are in heating operation. When the operator set it to the refrigerating or heating mode and the operation is opposite to the setting, it displays the awaiting indication.
	<ul style="list-style-type: none"> <li>• Sound in shutdown indoor unit or white steam or cold air</li> </ul>	To prevent oil and refrigerant from blocking the shutdown indoor units, refrigerant flows in the short time and make the sounds of refrigerant flowing. Otherwise, when other indoor units performs heating operation, white steam may occur; during refrigerating operation, cold air may appear.
	<ul style="list-style-type: none"> <li>• Clicking sound when switching the air condition on</li> </ul>	When the conditioner is powered on, the sound is made due to the resetting of the expansion valve.
Please make another check.	<ul style="list-style-type: none"> <li>• Start or stop working automatically</li> </ul>	Check if it is in the state of Timer-ON and Timer-OFF.
	<ul style="list-style-type: none"> <li>• Failure to work</li> </ul> 	Check if there is a power failure. Check if the manual power switch is turned off. Check if the supply fuse and breaker are disconnected. Check if the protective unit is working. Check if refrigerating and heating functions are selected simultaneously with the awaiting indication on line control.
	<ul style="list-style-type: none"> <li>• Bad cooling &amp; heating effects</li> </ul>	Check if air intake port and air outlet port of outdoor units are blocked. Check if the door and windows are open. Check if the filtering screen of air cleaner is blocked with sludge or dust. Check if the setting of wind quantity is at low wind. Check if the setting of operation is at the Fan Operation state. Check if the temperature setting is proper.

Under the following circumstances, immediately stop the operation, disconnect the manual supply switch and contact the after-service personnel.

- When buttons are inflexible actuated;
- When fuse and breaker have been burnt over and over;
- When there are foreign objects and water in the refrigerator;
- When it cannot still be operated after removing the operation of protective unit;
- When other abnormal conditions occur.

# Installation Procedures

This manual does not cover all user cases; please contact **Airwell** marketing centers in local places to propose new requirements and clear new doubts and problems.

Standard installation tools are recommended according to installation requirements. For information about standard model series accessories, see packing list; other necessary parts to be installed shall be prepared by users as required by installation service network stations.

**Decide upon places to install the indoor unit; places where even circulation of cool and warm air can be delivered shall be selected; and places below shall be avoided:**

※ Places (in coastal areas) where salinity is high; where sulfurized gases are usual (areas where springs flourish and copper tube and braze easily get corroded); where oils (machinery oils) and steam are usual; where organic solvents are put to use; where machines radiating high frequency electromagnetic waves exist (which cause control system malfunctions); where contact with humid air near windows and doors is pervasive (making for easy condensation) and; where special sprayers are put to frequent use.

## Installing Indoor Unit

1. Indoor unit must be used inside of room, not outdoor side, or some places with high humidity, like laundry.
2. The distance from air outlet to floor surface shall not exceed 2.7m.
3. Make sure that outlet airflow covers the whole room area; and arrange connecting tubes, wires and drain pipes to proper outdoor positions.
4. Make sure that ceiling structures are capable of bearing unit weight.
5. Connecting tubes, drain pipes and connecting wires can be put across walls to connect indoor unit and outdoor unit.
6. Connecting tubes and drain pipes between indoor and outdoor units shall be shorter for better.
7. Please refer to outdoor installation manual when refrigerant charging volume adjusting is necessary.
8. Joint flanges shall be prepared by users.
9. Valuables (e.g., TV sets, instruments, equipments, artworks, pianos, wireless devices) shall not be placed below the indoor unit lest condensed water drips upon the same.
10. The A/C cannot be used for drying clothes. It cannot be covered with clothes.

## Installing and Fixing

### 1. Drilling Wall Holes

Drill a wall hole (dia.70mm, see figure 1), slightly tilted downwards on the outside; fix guard ring to finalize before sealing the wall hole with gesso or putty.

### 2. Preparation prior to Installing Indoor Unit

Open inlet grille according to figure 2.

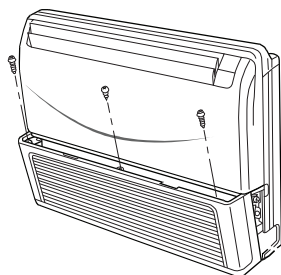

Figure 2 Model FAV012, FAV018, FAV024

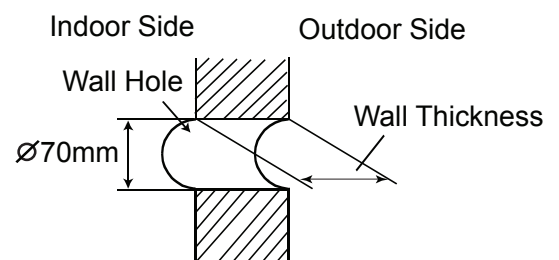

Figure 1 (Wall Hole in Section)

# Installation Procedures

## 3. Floor Type Installation

\*Fix four rubber feet to the bottom of the unit with  $\varnothing 4 \times 16$  bolts and  $\varnothing 12$  spacers (applicable to floor type units only).

\*According to figure on the right, choose a certain direction to lead out drain pipe; drain holes are available on both right and left sides; practical conditions shall be considered. After deciding upon the directions to lead out pipelines, wires and drain pipes, drill wall holes according to required drilling processes.

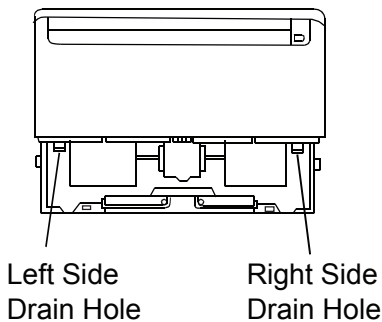
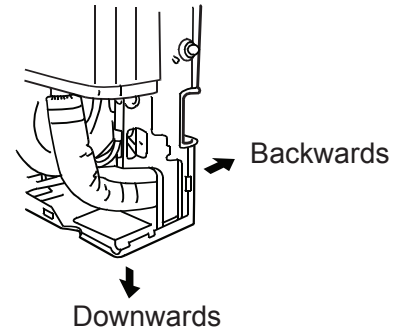
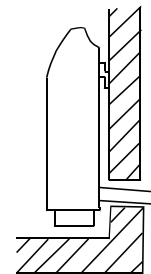
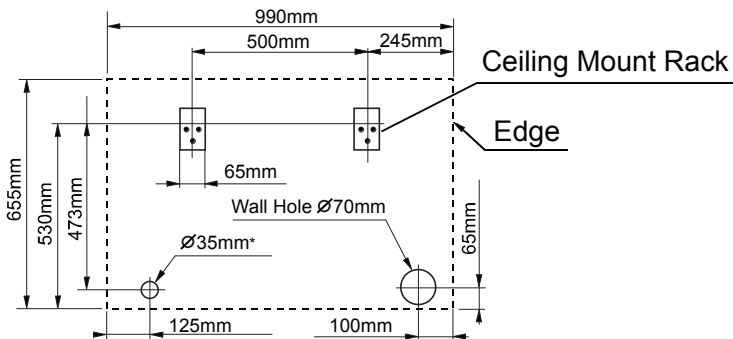

Figure 4 Model FAV012, FAV018, FAV024

\*Install wall mount rack according to figure below.



Model FAV012, FAV018, FAV024

### \*Installing Drain Pipe

In case of model 12-24, fix drain pipes to drain holes on left and right sides (as shown in figure 4 and figure 5).

Install as follows (see figure below):

Plug drain pipe in water pan in the first place, as shown by figure, then, bind the two tight together and tie up junction area with heat insulant.

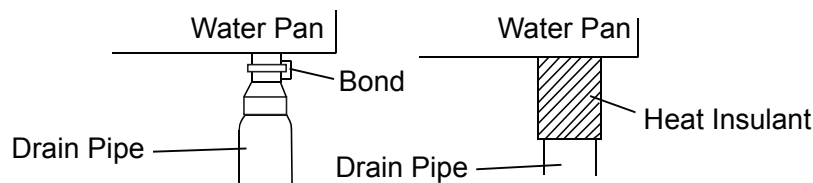

# Installation Procedures

CAUTION: drain pipe leading-out direction shown with figure below.

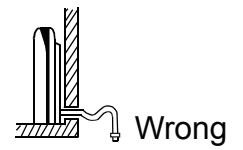
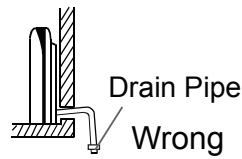
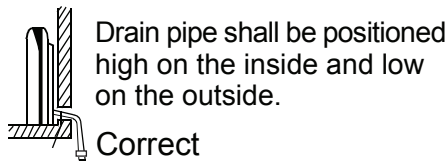

- Attention to distance from the unit to household usables or obstacles (as shown with figure).

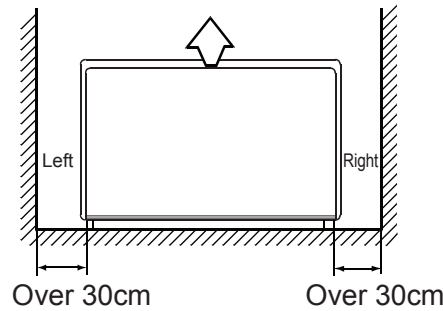

## 4.Ceiling Installation

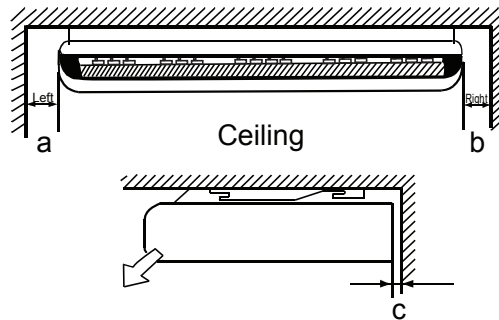

Model	a	b	c
FAV012, FAV018, FAV024	Over 30cm	Over 30cm	Over 2cm

## Ceiling Installation

\*Use  $\varnothing 10$  hanger bolts, prepared on the site.  
Please refer to figure on the right when installing.

FAV012, FAV018, FAV024

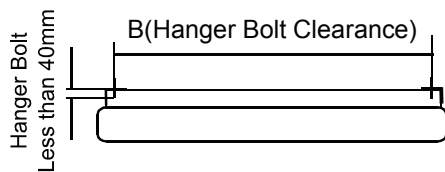

## Hanger Bolt Mounting Position

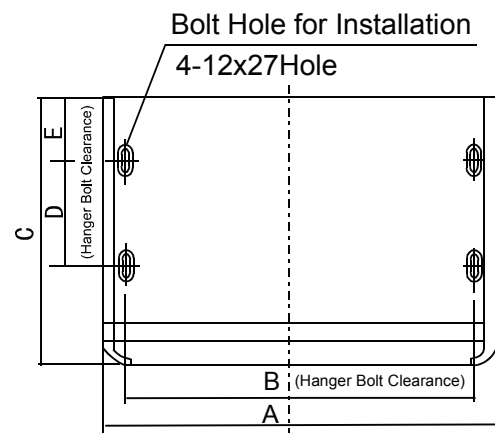

Model	A(mm)	B(mm)	C(mm)	D(mm)	E(mm)
FAV012, FAV018, FAV024	990	900	655	200	175



# Installation Procedures

---

## \*Installing Hanger Bolt

Use M10 hanger bolt (prepared on the site) featuring 60mm hole depth, clearance fixed according to size proposed in the air conditioner external view; install according to different building structure specifications to guard against safety faults; and leveling instruments shall be available to ensure balanced installation.

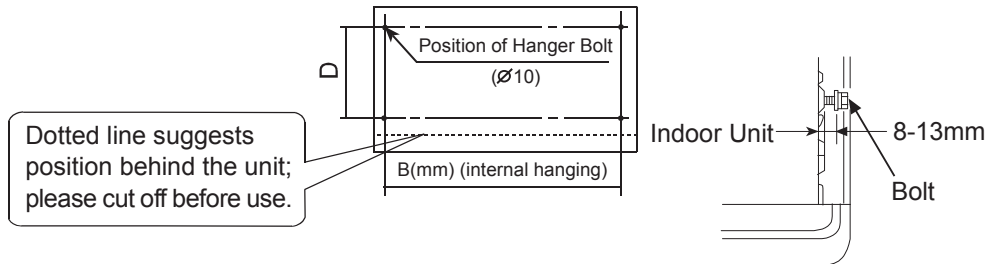

\*Please use hexagon bolts when installing

# Installation Procedures

## \*Air Conditioner Installation Diagram

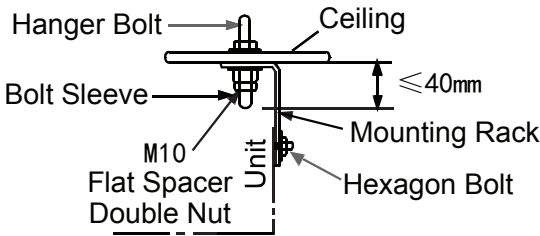
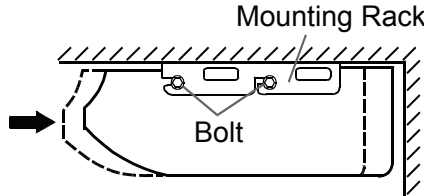
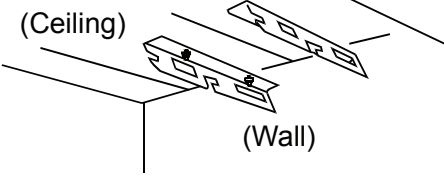
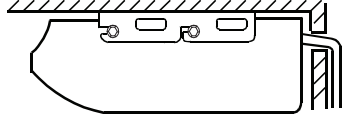
<p>* Hanger Chain Hook</p>	 <p>Hanger bolt is 40mm below ceiling.</p>	<p>* Installing Air Conditioner</p>	 <p>Insert hexagon bolt into slot</p> <p>Screw tight hexagon bolt to fix air conditioner</p>
<p>* Installing Status of Mounting Rack</p>	 <p>Leveling is forbidden after air conditioner is installed; please make adjustment according to diagram indication.</p>	<p>* Drain Pipe Leading-out Direction</p>	 <p>CAUTION: drain pipe shall be positioned high inside and low outside.</p> <p>According to requirements on the site, drain pipes shall be prepared by users on their own resources and make sure that these are connected to drain pipes previously available with the unit (make sure that measures are taken to guard against water leakage in junction areas); heat preservation shall be available with certain indoor drain pipes through using heat insulant to prevent condensation.</p>

\*Installing Deco Plate and Inlet Grille (after pipeline laying and electric wiring are done).

# Installation Procedures

## ⚠ Attention

- For normal drainage, the water drainage piping should be connected according to the installation manual. Heat insulation should be performed to avoid condensation. Improper pipe connection may cause water going into the machine.

### Requirements:

- Heat insulating treatment should be made for the water drainpipes of the indoor units.
- Heat preservation should be made for the connection with the indoor units. Improper heat preservation may cause condensing.
- The drainpipe should be designed with a down gradient of 1/100. The midway of the elbow shouldn't be made in S shape. Or abnormal noise may be caused.
- The lateral length of the drainpipe should be kept within 20m. Under the condition of long pipe, a support should be provided every 1.52~2m to avoid unevenness.
- The central piping can be connected according the following figure.
- Don't apply external force to the connection of drainpipes.

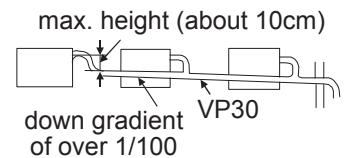
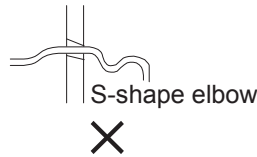
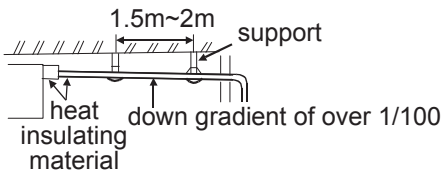

## Piping Materials & Heat Insulating Materials

As to prevent condensation, heat insulating treatment should be performed. The heat insulating treatment for piping should be done respectively.

Piping Material	Hard PVC tube VP31.5mm (inner bore)
Heat Insulating Material	Vesicant polythene thickness: over 7mm

## Hose

The drainage hose is made of  $\varnothing$  19.05mm (3/4") PVC tube, which can adjust the eccentricity and the angle of the hard PVC tube.

- Stretch the hose directly to make connections as to avoid distortion. The soft end of the hose should be positioned with a clamp.
- The hose should be used in the horizon direction.

### Heat Insulating Treatment:

- Wrap the connection between the clamp and the root segment of the indoor unit without any gap with heat insulating materials as shown in the drawing

## Confirming water drainage

During the test run, check the condition of water drainage and make sure that there is no leakage on the connection of piping, which should also be performed during the winter.

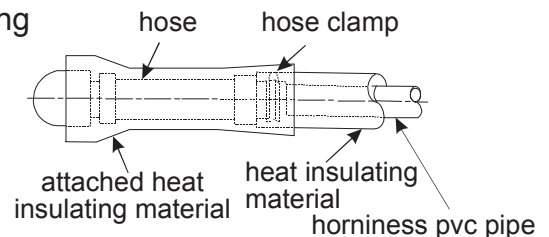

# Installation Procedures

## Tubing Permissible Length & Height Difference

Please refer to the attached manual of outdoor units.

## Tubing Materials & Specifications

Model		FAV012, FAV018	FAV024
Tubing Size (mm)	Gas pipe	∅12.7	∅15.88
	Liquid pipe	∅6.35	∅9.52
Tubing Material		Phosphor deoxybronze seamless pipe (TP2) for air conditioner	

## Refrigerant Filling Amount

Add the refrigerant according to the installation instruction of outdoor unit. The addition of R410A refrigerant must be performed with a measure gage to ensure the specified amount while compressor failure can be caused by filling too much or little refrigerant.

## Connecting Procedures of Refrigerant Tubing

Proceed the flare tube connecting operation to connect all the refrigerant tubes.

- Dual wrenches must be used in the connection of indoor unit tubing.
- Mounting torque refers to the right table

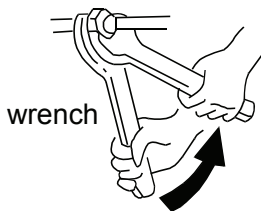

Outer Diameter of Tubing (mm)	Mounting Torque (N-m)	Increase mounting Torque (N-m)
∅6.35	11.8(1.2kgf-m)	13.7(1.4kgf-m)
∅9.52	24.5(2.5kgf-m)	29.4(3.0kgf-m)
∅12.7	49.0(5.0kgf-m)	53.9(5.5kgf-m)
∅15.88	78.4(8.0kgf-m)	98.0(10.0kgf-m)

## Cutting and Enlarging

Cutting or enlarging pipes should be proceeded by installation personnel according to the operating criterion if the tube is too long or flare opening is broken.

## Vacuumizing

Vacuumize from the stop valve of outdoor units with vacuum pump. Refrigerant sealed in indoor machine is not allowed to use for vacuumization.

## Open All Valves

Open all the valves of outdoor units. [NB: oil balancing stop valve must be shut up completely when connected one main unit.]

## Checkup for Air Leakage

Check if there is any leakage at the connecting part and bonnet with hydrophone or soapsuds.

## Connecting

Connecting circular terminals:



- Connecting circular terminals:**  
The connecting method of circular terminal is shown in the Fig. Take off the screw, connect it to the terminal tier after heading it through the ring at the end of the lead and then tighten it.
- Connecting straight terminals:**  
The connection methods for the circular terminals are shown as follows: loosen the screw before putting the line terminal into the terminal tier, tighten the screw and confirm it has been clamped by pulling the line gently.
- Pressing connecting line**  
After connecting line is completed, press the connecting line with clips which should press on the protective sleeve of the connecting line.

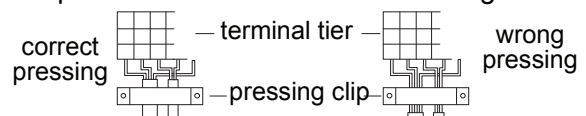

# Installation Procedures

## 1. Take down wire controller from the holder

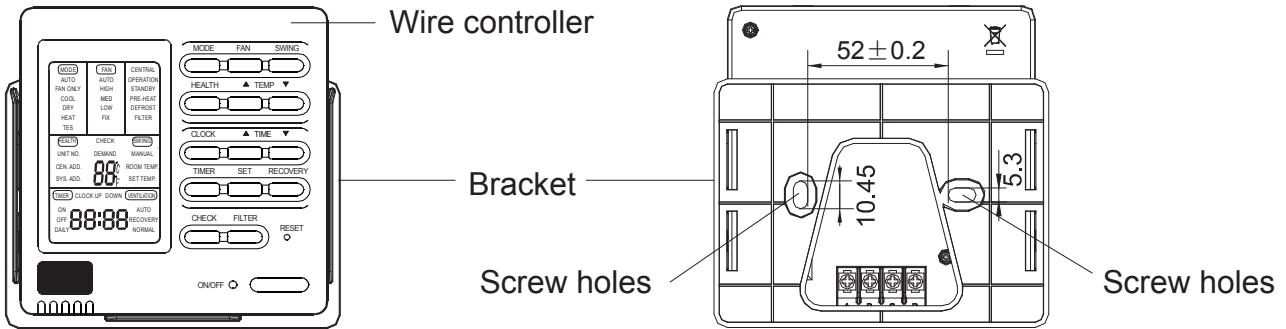

## 2. Install the controller holder

According to the position of 2 screw holes on the holder, drill 2 holes on the wall, and strike the wood stopper to the holes respectively.

Then align the 2 screw holes of wired controller holder to the wood stopper, fix the holder on the wall with wood screw.

### Note:

Try a wall as flat as possible for installation. Don't use excessive force to tighten screws, otherwise, the holder will be damaged.

## 3. Wiring instruction

Use shielded wire between indoor and wire controller. And be earthed on one side, or the unit will not work normally because of interference.

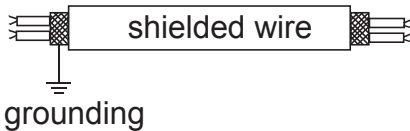

### Note:

Confirm the terminal connection firmly, and do not get in touch with shielded wire. Don't touch the PC panel with your hands.

## 4. Place wire controller on the holder, and pay attention not to pressing any wires.

# Electrical Wiring

## ⚠ Warning

- Electrical construction should be made with specific mains circuit by the qualified personnel according to the installation instruction. Electric shock and fire may be caused if the capacity of power supply is not sufficient. **!**
- During arranging the wiring layout, specified cables should be used as the mains line, which accords with the local regulations on wiring. Connecting and fastening should be performed reliably to avoid the external force of cables from transmitting to the terminals. Improper connection or fastness may lead to burning or fire accidents. **!**
- There must be the ground connection according to the criterion. Unreliable grounding may cause electrical shocks. Do not connect the grounding line to the gas pipe, water pipe, lightning rod and telephone line. **!**

## ⚠ Attention

- Only copper wire can be used. Breaker for electric leakage should be provided, or electric shock may occur.
- The wiring of the mains line is of Y type. The power plug L should be connected to the live wire and plug N connected to null wire while ⊕ should be connected to the ground wire. For the type with auxiliary electrically heating function, the live wire and the null wire should not be misconnected, or the surface of electrical heating body will be electrified. If the power line is damaged, replace it by the professional personnel of the manufacturer or service center.
- The power line of indoor units should be arranged according to the installation instruction of indoor units.
- The electrical wiring should be out of contact with the high-temperature sections of tubing as to avoid melting the insulating layer of cables, which may cause accidents.
- After connected to the terminal tier, the tubing should be curved into be a U-type elbow and fastened with the pressing clip.
- Controller wiring and refrigerant tubing can be arranged and fixed together. **!**
- The machine can't be powered on before electrical operation. Maintenance should be done while the power is shut down.
- Seal the thread hole with heat insulating materials to avoid condensation.
- Signal line and power line are separately independent, which can't share one line. [Note: the power line, signal line are provided by users. Parameters for power lines are shown as below:  $3 \times (1.0-1.5) \text{ mm}^2$ ; parameters for signal line:  $2 \times (0.75-1.25) \text{ mm}^2$  ( shielded line)]
- 5 butt lines (1.5mm) are equipped in the machine before delivery, which are used in connection between the valve box and the electrical system of the machine. The detailed connection is displayed in the circuit diagram.

Supply Wiring Drawing

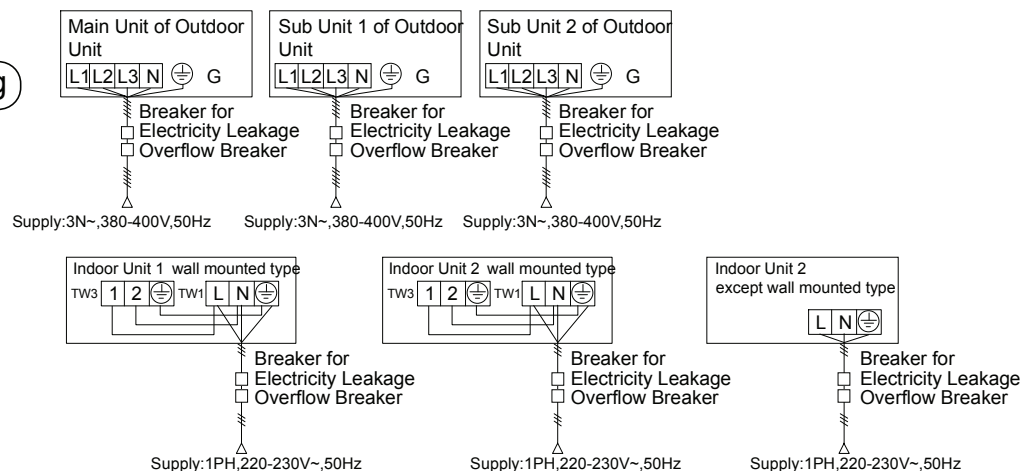

- Indoor units and outdoor units should be connected to the power source separately. Indoor units must share one single electrical source, but its capacity and specifications should be calculated. Indoor & outdoor units should be equipped with the power leakage breaker and the overflow breaker.
- An all-pole disconnection switch having a contact separation of at least 3mm in all poles should be connected in fixed wiring.

# Electrical Wiring

## Signal Wiring Drawing

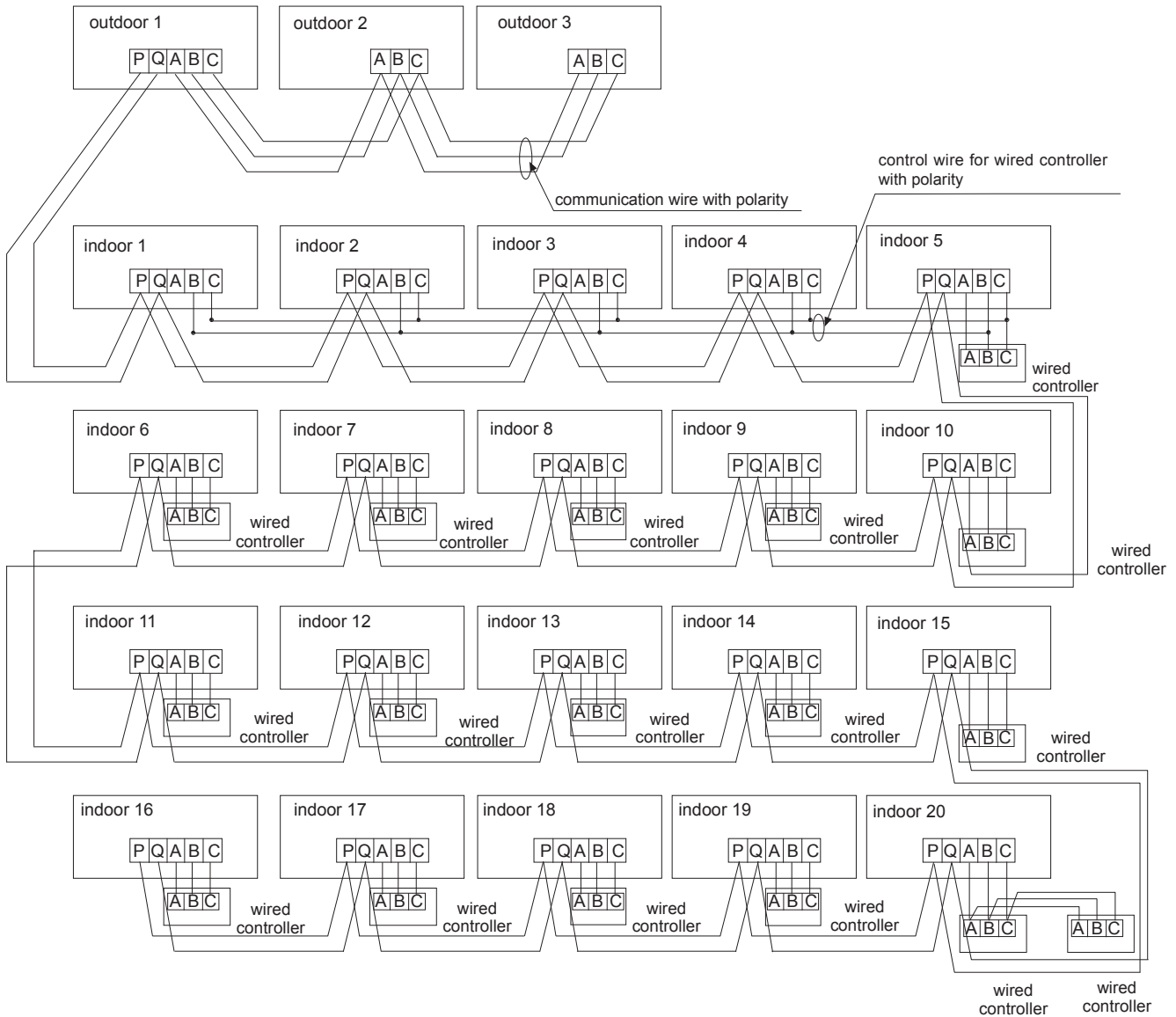

Outdoor units are of parallel connection via three lines with polarity. The main unit, central control and all indoor units are of parallel connection via two lines without polarity.

There are three connecting ways between line control and indoor units:

- A. One line control controls multiple units, i.e. 2-16 indoor units, as shown in the above figure, (1-5 indoor units). The indoor unit 5 is the line-controlled main unit and others are the ine-controlled sub units. The remoter control and the main unit (directly connected to the indoor unit of line control) are connected via three lines with polarity. Other indoor units and the main unit are connected via two lines with polarity. SW01 on the main unit of line control is set to 0 while SW01 on other sub units of line control are set to 1, 2, 3 and so on in turn. (Please refer to the code setting A at page 31)
- B. One line control controls one indoor unit, as shown in the above figure(indoor unit 6-19). The indoor unit and the line control are connected via three lines with polarity.
- C. Two line controls control one indoor unit, as shown in the figure (indoor unit 20). Either of the line controls can be set to be the master line control while the other is set to be the auxiliary line control. The master line control and indoor units, and the master and auxiliary line controls are connected via three lines with polarity.

When the indoor units are controlled by the remote control, switch over the modes by Switching Mode of Line-Controlled Main Unit/ Line-Controlled Sub Units/ Remote-Controlled Types. The signal terminals needn't to be equipped with wires and connected to the line control.

# Electrical Wiring

The combination of multiple indoor units can be controlled by wired controller or remote controller.

※ Switching Mode of Line-Controlled Main Unit/ Line-Controlled Sub Units/ Remote-Controlled Types can be used for switching over ※

Socket/ Dip switch \ Setting Mode	Master Remote Wired Controller	1# Remote Wired Controller	Wireless Remote Controller
SW01-[1][2][3][4]	All OFF	[0][0][0][1]	All OFF
CN21 Socket	Null	Null	Connect to remote receiver
Terminal Block (Control)	A,B,C connect with Wireless Remote Controller	B,C connect with Wireless Remote Controller	A,B,C Null

Note:FAV models are set to remote- controlled type before delivery

The wiring for the power line of indoor unit, the wiring between indoor and outdoor units as well as the wiring between indoor units:

Total Current of Indoor Units (A) \ Items	Cross Section (mm <sup>2</sup> )	Length (m)	Rated Current of Overflow Breaker(A)	Rated Current of Power Leakage Breaker (A) Leaking Current(mA) Operating Period (S)	Cross Sectional Area of Signal Line	
					Outdoor -indoor (mm <sup>2</sup> )	Indoor -indoor (mm <sup>2</sup> )
<10	2	20	20	20 A,30 mA,0.1S or below	2 cores × 0.75-2.0 mm <sup>2</sup> shielded line	
≥10 and <15	3.5	25	30	30 A,30 mA,0.1S or below		
≥15 and <22	5.5	30	40	40 A,30 mA,0.1S or below		
≥22 and <27	10	40	50	50 A,30 mA,0.1S or below		

- ※ Power cable model: H05VV-F
- ※ The diameter of earth cable cannot be smaller than power cable's.
- ※ The electrical power line and signal lines must be fastened tightly.
- ※ Every indoor unit must have the ground connection.
- ※ The power line should be enlarged if it exceeds the permissible length.
- ※ Shielded lays of all the indoor and outdoor units should be connected together, with the shielded lay at the side of signal lines of outdoor units grounded at one point.
- ※ It is not permissible if the whole length of signal line exceeds 1000m.

## Signal Wiring of Wired controller

Length of Signal Line (m)	Wiring Dimensions
<100	0.3mm <sup>2</sup> × 3 core shielding line
≥100 and <200	0.5mm <sup>2</sup> × 3 core shielding line
≥200 and <300	0.75mm <sup>2</sup> × 3 core shielding line
≥300 and <400	1.25mm <sup>2</sup> × 3 core shielding line
≥400 and <600	2mm <sup>2</sup> × 3 core shielding line

- ※ The shielding lay of the signal line must be grounded at one end.
- ※ The total length of the signal line shall not be more than 600m.



# Electrical Wiring

## Dip switch setting

Indoor PCB

In the following table, 1 is ON, 0 is OFF.

SW01 is used for indoor unit group control address setting and capacity selection. CN44,CN42,CN43 are used for indoor unit type selection. CN41 is used for addressing by wired controller. SW03 is used for indoor unit address setting (including physical address and central address). SW07 is used for running mode setting. J1-J8 are used for fan motor setting.

(1) Description of SW01

SW01_1 SW01_2 SW01_3 SW01_4	Wired control address	[1]	[2]	[3]	[4]	Wired control address
		0	0	0	0	Master unit in group control
		0	0	0	1	Slave unit 1 in group control
		0	0	1	0	Slave unit 2 in group control
		0	0	1	1	Slave unit 3 in group control
		...	...	...	...	.....
SW01_5 SW01_6 SW01_7 SW01_8	Indoor unit capacity	[5]	[6]	[7]	[8]	Indoor unit capacity
		0	0	0	0	0.6HP
		0	0	0	1	0.8HP
		0	0	1	0	1.0HP
		0	0	1	1	1.2HP
		0	1	0	0	1.5HP
		0	1	0	1	1.7HP
		0	1	1	0	2.0HP
		0	1	1	1	2.5HP
		1	0	0	0	3.0HP
		1	0	0	1	3.2HP
		1	0	1	0	4.0HP
		1	0	1	1	5.0HP
		1	1	0	0	6.0HP
1	1	0	1	8.0HP		
1	1	1	0	10.0HP		
1	1	1	1	15.0HP		

(2) CN41,CN42,CN43,CN44 plug explanation

CN41	Set address by wired controller	0	Set the address with wired controller is unavailable (default)		
		1	Set the address with wired controller is available (When SW03_1 is off)		
CN42 CN43 CN44	Indoor type	CN44	CN42	CN43	Indoor type
		0	0	0	Normal indoor (default)
		0	0	1	Wall mounted
		0	1	0	Fresh air unit
		0	1	1	OEM (HRV)
		1	0	0	Ceiling floor
		1	0	1	Reserve (general indoor unit)
		1	1	0	Reserve (general indoor unit)
		1	1	1	Reserve (general indoor unit)

### Note

- 0 stands for open circuit, 1 stands for socket short circuit connection.
- CN41 must be in short circuit, and SW03\_1 at OFF when addressing by wired controller.
- Using wired controller modifying physical address or central control address, the other corresponding address can change automatically, meeting as follows: Central control address equals to physical address plus 0 or 64.

# Electrical Wiring

## (3) Description of SW03

SW03_1	Manner of set address	0		Set the address with wired controller or automatism (default)						
		1		Set the address with dip switch						
SW03_2 ~ SW03_8	Set the Communication and Central control address with dip switch (*Note)	[2]	[3]	[4]	[5]	[6]	[7]	[8]	Communication address	Central control address
		0	0	0	0	0	0	0	0# (default)	0# (default)
		0	0	0	0	0	0	1	1#	1#
		0	0	0	0	0	1	0	2#	2#
		...	...	...	...	...	...	...	...	...
		0	1	1	1	1	1	1	63#	63#
		1	0	0	0	0	0	0	0#	64#
		1	0	0	0	0	0	1	1#	65#
		1	0	0	0	0	1	0	2#	66#
		...	...	...	...	...	...	...	...	...
1	1	1	1	1	1	1	63#	127#		

**\*Note**

1. The address must be set by dip switch if central control is used.
2. SW03-2=OFF, central control address = physical address +0  
SW03-2=ON, central control address= physical address +64
3. The address must be set by dip switch if 0010451181A and 0151800113 are used together.

## (4) Description of SW07

SW07_1 SW07_2	Tdiff correction valve in AUTO mode	[1]	[2]	Tdiff correction valve in AUTO mode
		0	0	Tdiff:0
		0	1	Tdiff:1
		1	0	Tdiff:2
SW07_3	26°C lock	1	Normally, without 26 degree lock function (defaulted)	
		0	26 degree lock function is available(In cooling mode, though set temp. is below 26 degree,count as 26 degree. In heating mode, though set temp. exceeds 20 degree, count as 20 degree)	
SW07_4 SW07_5	In heating, inlet air temp. Tai correction valve Tcomp2	[4]	[5]	Inlet air temp. Tai correction valve Tcomp2 (eeprom)
		0	0	Tai correction valve=12°C
		0	1	Tai correction valve=4°C
		1	0	Tai correction valve=8°C
SW07_6	Room card. OEM HRV linkage	1	Room card function is unavailble, HRV linkage function is unavailble (default)	
		0	Room card function and HRV linkage function is available	
SW07_7 SW07_8	Operation mode changeover of wired controller	[7]	[8]	Function
		0	0	[FAN] [COOL] [DRY] [HEAT]
		0	1	[FAN] [COOL] [DRY]
		1	0	[FAN] [COOL] [DRY] [HEAT] [ELECTRIC-HEAT]
1	1	[AUTO] [FAN] [COOL] [DRY] [HEAT] (default)		

# Electrical Wiring

## (5) Description of jump wire:SW08(1:ON, 2:OFF)

J1	Fix air volume	1	Normal mode(default)
		0	Air volume is fixed at high speed (for duct type)
J2	Run at Mid speed when Hi Speed is selected	1	Normal mode(default)
		0	Run at Mid speed when Hi Speed is selected
J3	Quiet running mode	1	Normal mode(default)
		0	Quiet running mode
J4	This Indoor has highest priority	1	Normal mode (default)
		0	This Indoor has highest priority (the target degree of superheat reduce 1 degree when Tao is between 10 and 43 degree)
J5	Indoor and outdoor 90 meters drop selection	1	Normal mode (default)
		0	High drop
J6	Reserved	--	--
J7	Indoor installation height selection	1	Normal mode (default)
		0	Above 2.7m, uses next higher fan speed (indoor fan speed improve 1 grade)
J8	Twin energy source	1	Normal mode- TES is unavailable (default)
		0	TES is available

### Code setting of wired controller

#### Function switches

Code	Switch status	Function description	Default setting	Remarks
SW1	ON	Auxiliary wired controller	OFF	
	OFF	Master wired controller		
SW2	ON	Common wired controller	ON	
	OFF	New fan-only has refrigerating, heating, and air supplying modes		
SW3	ON	Display ambient temperature	OFF	
	OFF	Do not display ambient temperature		
SW4	ON	26°C lock disabled	ON	
	OFF	26°C lock enabled		
SW5	ON	Collect ambient temperature of wired controller	ON	
	OFF	Collect ambient temperature of PCB		
SW6	ON	Power failure memory disabled	OFF	
	OFF	Power failure memor enabled		
SW7	ON	Temperature sensor 4k7 enabled	ON	
	OFF	Temperature sensor 4k7 disabled		
SW8	ON	Temperature sensor 5k1 enabled	OFF	
	OFF	Temperature sensor 5k1 disabled		

Note: ON indicates short circuit; OFF indicates disconnection.

## (6) Jumper explanation

a) EEV operation manually (CN27, CN29)

CN27: short circuit CN27 2 seconds continuously, EEV is opened fully.

CN29: short circuit CN29 2 seconds continuously, EEV is closed fully.

b) time-short and self-check (CN28)

Short circuit CN28 2 seconds after power ON, process into time-short. Short circuit CN28 before power ON, process into self-check.

Note:

0 indicates disconnection, 1 indicates short circuit.

Default position:

SW01: depend on unit capacity.

CN41, CN42, CN43: open circuit.

CN44: open circuit except of floor ceiling unit.

SW07: all ON. J1-J8: all ON.

The difference between master and slave wired controller

Topic	Master controller	Slave controller
Function	All function	ON/OFF, Mode, Fan speed, Temp, Swing function only.

# Functions of Wired Controller

## Operation of Wired/Remote Controllers

- ① Initialization process of line control:  
During the initialization of line control after powered on, [8888]→[888]→[88]→[8] for the wired controllers and LED flash for about 30 seconds. At this time, all buttons are disabled.
- ② Descriptions of other components and operating methods refer to the related operating guide.
- ③ Special functions of wired control:
  - A Setting of central control address of indoor units:  
When indoor unit code setting allows line control to set the address, continually press “Resetting Filtering Screen” for 10 seconds to enter into the mode of setting the central control addresses, and select the unit No. of the group by “Time +/-” button.  
Indication of temperature displays:  
[Central Control Address]+XX: Press “Temp. +/-” button. XX ranges from 0-7F with the initial value of 00. After finishing the setting, press “Setting” button to save the setting and quit. By pressing other buttons or without pressing within 15 seconds, it will automatically quit and keep the last setting.
  - B Setting of communication address between indoor units and outdoor units:  
When indoor unit code setting allows line control to set the address, continually press “Resetting Filtering Screen” for 5 seconds to enter into the mode of setting the communication addresses, and select the unit No. of the group by “Time +/-” button.  
Indication of temperature displays:  
[System Address]+XX: Press “Temp. +/-” button. XX ranges from 0-3F with the initial value of 00. After finishing the setting, press “Setting” button to save the setting and quit. By pressing other buttons or without pressing within 15 seconds, it will automatically quit and keep the last setting.
  - C Inquiry of fault records of indoor units:  
In the state of startup or shutdown, press “CHECK” button to go into the mode of inquiring faults of all indoor units in this group. The temperature zone indicates “CHECK” and “Unit No.”, which shows the unit number with the actual connection in sequence in the decimal system. Meanwhile, the time zone indicates the code of the current fault and the previous fault of the responding machine in the format of [XX:YY], in which, XX refers to the code of the current fault (if normal, it shows “- -”) and YY refers to the code of the previous fault. The indication of fault code of each machine lasts 3 seconds. After the indication of the whole group, it automatically quit.  
Removing abnormal states & clearing fault records:
  - D Under normal conditions, continually press “CHECK” button for 5 seconds to clear fault records.  
Inquiring running state of indoor units of the group:
  - E Under normal condition, press “Setting” button for 5 seconds until the temperature zone on the liquid crystal screen shows [XX], referring to the unit number of indoor units and select unit, and select unit number by “Temp. +/-” button. The time zone displays [YZZZ], in which, Y refers to the data type and ZZZ to the responding data. Select the data type by “Time +/-” button.

Y	ZZZ	System
A	Temperature of indoor unit transducer TA	Actual value, decimal system
B	Temperature of indoor unit transducer TC1	Actual value, decimal system
C	Temperature of indoor unit transducer TC2	Actual value, decimal system
D	PMV step of indoor units	Actual value/2. decimal system(e.g. indication of 50 with actual step of 100)
E	Communication address between indoor/outdoor units	Actual value, sexadecimal system
F	Central address	Actual value, sexadecimal system

Under the inquiring state, press “CHECK” button to quit the inquiring state and return to the normal operating state.

# Test Run & Fault Code

---

## Before Test Run

- Before switching it on, test the supply terminal tier (L, N terminals) and grounding points with 500V megaohm meter and check if the resistance is above 1M\*. It can't be operated if it is below 1M\*.
- Connect it to the power supply of outdoor units to energize the heating belt of the compressor. To protect the compressor at startup, power it on 12 hours prior to the operation.

### **Check if the arrangements of the drainpipe and connection line are correct.**

The drainpipe shall be placed at the lower part while the connection line placed at the upper part. Heat preservation measures should be taken such as winding the drainpipe esp. in the indoor units with heating insulating materials.

The drain pipe should be made a slope type to avoid protruding at the upper part and concaving at the lower part on the way.

### **Checkup of Installation**

- check if the mains voltage is matching
- check if there is air leakage at the piping joints
- check if the connections of mains power and indoor & outdoor units are correct
- check if the serial numbers of terminals are matching
- check if the installation place meets the requirement
- check if there is too much noise
- check if the connecting line is fastened
- check if the connectors for tubing are heat insulated
- check if the water is drained to the outside
- check if the indoor units are positioned

## Ways of Test Run

Do ask the installation personnel to make a test run. Take the testing procedures according to the manual and check if the temperature regulator works properly.

When the machine fails to start due to the room temperature, the following procedures can be taken to do the compulsive running. The function is not provided for the type with remote control.

- Set the wired controller to refrigerating/heating mode, press "ON/OFF" button for 5 seconds to enter into the compulsive refrigerating/heating mode. Repress "ON/OFF" button to quit the compulsive running and stop the operation of the air conditioner.

# Test Run & Fault Code

---

## Fault Remedies

When any fault appears, refer to “Inquiry of fault records of indoor units” at page33, consult the fault code of line control or the flashing times for LED5 of computer panel of indoor units/health lamp of receiving window of remote control and find out the faults as shown in the following table to remove all faults.

### Indoor Unit Faults

Wired Controller Fault Code	PCB LED5(Indoor Units)/ Receiving Window Health Lamp(Remote Controller)	Fault Descriptions
01	1	Fault of indoor unit ambient temp. transducer TA
02	2	Fault of indoor unit pipe temp. transducer TC1
03	3	Fault of indoor unit pipe temp. transducer TC2
04	4	Fault of indoor unit dual heat source temp. transducer
05	5	Fault of indoor unit EEPROM
06	6	Fault of communication between indoor & outdoor units
07	7	Fault of communication between indoor unit and wired control
08	8	Fault of indoor unit water drainage
09	9	Fault of duplicate indoor unit address
0A	10	Fault of duplicate central control address
Outdoor Unit Code	20	Corresponding faults of outdoor units

# Disposal

---

## **DISPOSAL:**

Do not dispose this product as unsorted municipal waste. Collection of such waste separately for special treatment is necessary.

It is prohibited to dispose of this appliance in domestic household waste.

For disposal there are several possibilities:

- a) The municipality has established collection systems, where electronic waste can be disposed of at least free of charge to the user.
- b) When buying a new product, the retailer will take back the old product at least free of charge.
- c) The manufacturer will take back the old appliance for disposal at least free of charge to user.
- d) As old products contain valuable resources, they can be sold to scrap metal dealers.

Wild disposal of waste in forests and landscapes endangers your health when hazardous substances leak into the ground-water and find their way into the food chain.