



OPERATING INSTRUCTIONS

"CLASSIC" Range

RECTO / VERSO FIREPLACE

Contents

1	Foreword	3
2	Operating instructions.....	4
2.1	Basic safety rules	4
2.1.1	General points.....	4
2.1.2	Fire hazard zone	4
2.1.3	In the event of fire propagation in the flue.....	5
2.2	How does your Totem fireplace work?.....	6
2.2.1	Door	7
2.3	Combustion adjustment elements.....	9
2.3.1	Smoke damper trap.....	9
2.3.2	Control lever for smoke damper trap	11
2.3.3	Combustion air	12
2.3.4	Reflectors.....	13
2.4	Using your appliance for the first time.....	14
2.5	How to operate the fire	15
2.5.1	Lighting	15
2.5.2	Adding wood	17
2.5.3	Extinction.....	18
2.6	Initial checks in case of poor functioning.....	19
2.7	Maintenance guide	20
2.7.1	Cleaning the glass.....	20
2.7.2	Cleaning the fireplace.....	21
2.7.3	Maintenance and Chimney Sweeping	22
2.8	Maintenance record.....	25
3	Basic information about firewood.....	26
3.1	General points.....	26
3.2	Drying of wood and its moisture content.....	29
3.3	Types of fuel which are forbidden	30
4	Dimensions.....	31
5	EC certifications	32
6	Warranty.....	33
6.1	Statutory warranty	33
6.2	Contract guarantee.....	33
6.3	The following are not covered by the warranty.....	33

1 Foreword

You have purchased a Totem fireplace, thank you for your custom.

Read these operating instructions carefully in order to obtain the best and safest use of your new installation.

Totem fireplaces are high-tech, high-performance appliances, in particular with regard to safety.

Installation of the fireplace, its accessories and the materials which surround it must be carried out according to best practice and in compliance with all local and national regulations as well as all national and European standards.

A qualified professional shall have ensured, in particular, that the characteristics of the chimney flue and its environment are suitable for the fireplace to be installed.

Any modification to your Totem fireplace will render the warranty null and void.

If you have any questions about how the appliance works, please contact your fitter.

The explanations in this manual apply to all Totem Recto/Verso fireplaces (excluding products in the Technika range)

To make these operating instructions easier to read and understand, we have used general illustrations and terms corresponding to a particular type of appliance. The images used may differ from your appliance.

For further information, consult our Internet site: www.totemfire.com

2 Operating instructions

2.1 Basic safety rules

2.1.1 General points

- Your Totem fireplace is fitted with foldaway swinging doors which allow it to operate with the door lowered (shut) in complete safety and the door raised (open) like a traditional fireplace.
- When using the fireplace with the door raised (open), the fireplace must be permanently supervised. Watch out for flying embers.
- It is essential to wear protective gloves or use the safe handling tool to handle the door. When the door is lowered (shut) the accessible surfaces of the frame of the door and the vitrocereamics rise considerably in temperature when the appliance is in operation and can cause burns when touched.
- Explain the risks of burns to children and ensure that they are not close to the fireplace when it is in use.
- It is strictly forbidden to open the swinging door when the appliance is in use (see page 8)

2.1.2 Fire hazard zone

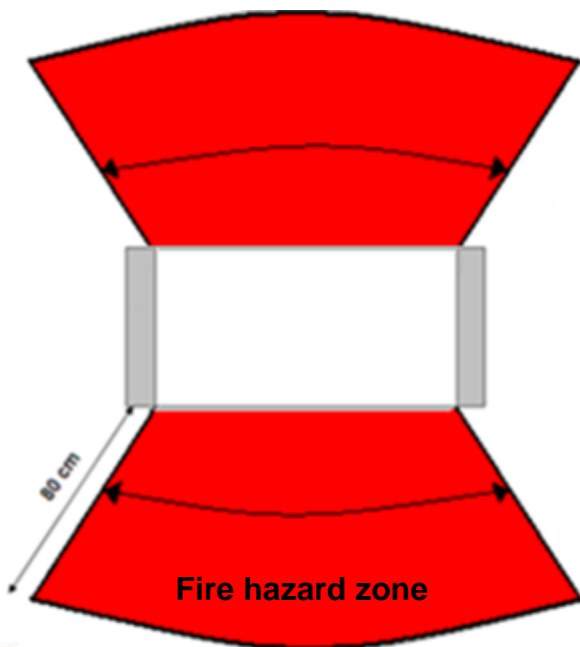

Do not store flammable items within an 80 cm radius around the fireplace door.

(logs, tables, chairs, firelighters...)

No flammable material must be placed in the appliance's fire hazard zone.



2.1.3 In the event of fire propagation in the flue

If maintenance and operating conditions are adhered to, there is no risk of fire in your flue. Nevertheless, please read these rules concerning chimney flue fires.

Never use water to put out the fire. Water causes thermal shock which could cause the bricks and vitro-ceramics of the fireplace to explode.

Close all the combustion air inlets, the smoke damper trap as well as the door, using the safe handling tool to extinguish the fire.

Move any flammable objects away from the fireplace.

Call the fire brigade.



In the European Union
dial 112



Before using again, it is compulsory to have the entire installation (especially the ducts) checked and cleaned by a qualified professional.

A fit for use certificate provided by a professional is compulsory.

2.2 How does your Totem fireplace work?

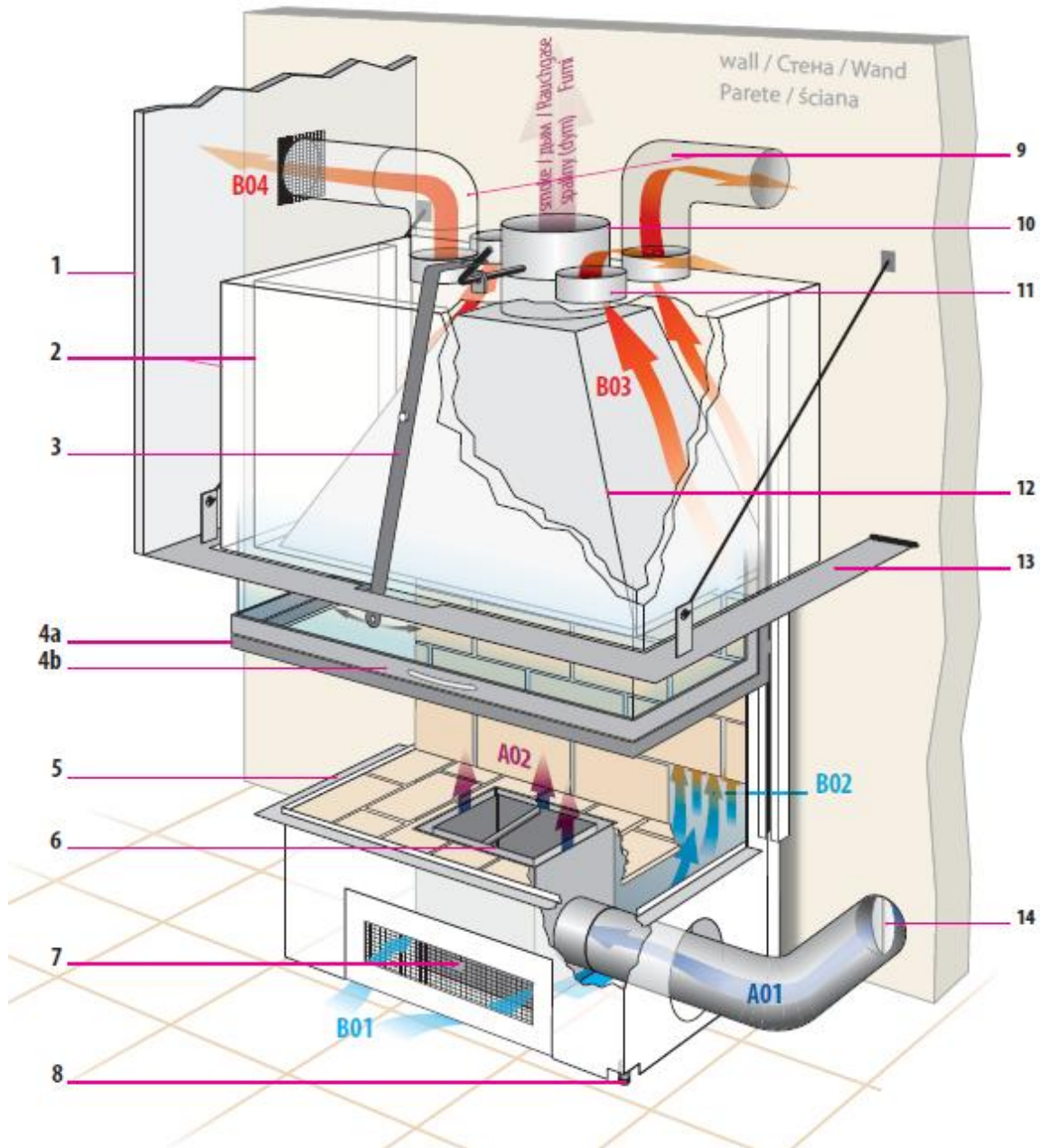

1- Extractor covering
2- double lining of the fireplace (smoke box)
3- control lever for smoke damper - (pictures 1,2,3)
4a- foldaway door
4b- opening part of the door, for cleaning the screen - (picture 8)
5- support fender (sealed with door closed)
6- removable ash tray fitted with a grill with adjustable opening - (pictures 4,5,6,7)

7- ash tray box (with combustion air inputs pre-cut) - (picture 9)
8- level adjustment screw
9- hot air casing (not supplied)
10- smoke vent (with damper)
11- 4 hot air vents
12- trap
13- hood support iron (optional)
14- Damper with outside air intake control valve (available as an optional extra)

A01- combustion air (external input)
A02- combustion air
B01- convection air (ambient air)
B02- convection air moving up the lining
B03- circulating convection hot air
B04- redistributed hot air

2.2.1 Door

4a

Foldaway door

Your Totem fireplace is fitted with a foldaway door. This is used to make the appliance function on a daily basis.

To optimise heating performance and use the fire in complete safety, fully lower the door.

Separating R°V° fireplaces have a **foldaway swinging** door and an exclusively **swinging** door.

Central R°V° fireplaces have two **foldaway swinging** doors. There is a main door and a secondary door. The main door controls the automatic smoke damper trap (see page 10).

ALWAYS OPEN THE MAIN DOOR FIRST

To prepare the fire and add wood or to take full advantage of a traditional fire, raise the door.

Our doors are fitted with a stainless steel handle to facilitate use.

When the appliance is hot, use a glove or the safe handling tool to operate it.

Open the door by a few centimetres before fully opening to prevent down draughts.

Note: To prevent smoke from being discharged into your house, never allow your fireplace to operate with the door half open.

Door raised
↑
↓
Door lowered



The Totem safe handling tool

The safe handling tool, supplied with every fireplace, allows the various elements of the fireplace to be handled without risk of burns.



Forge effect

When the appliance is functioning with the door closed, there must be no passage of air under the door.

Check that nothing is preventing the door from closing correctly (embers, pieces of wood...)

The air flow entering the fireplace is accelerated by the reduced passage under the door.

This air causes the fire to be over active. The wood burns too quickly

The appliance becomes less efficient.

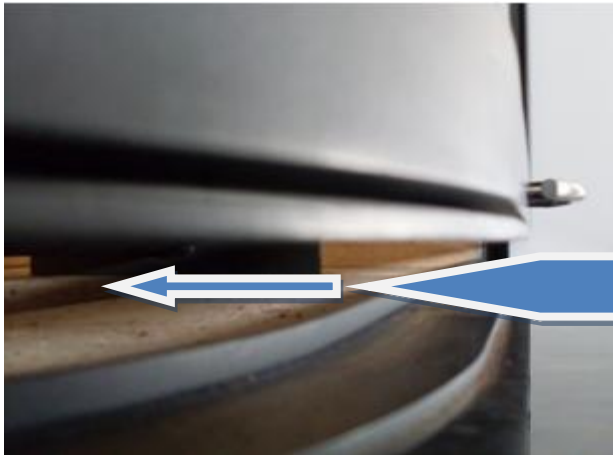

AIR

The door must be **COMPLETELY** closed.

4b

Swinging door

The swinging door must only be used for cleaning the glass, never for operation with the door open or for loading wood.

To open the swinging door, lower the door to the maximum,

Raise the latch (1), located on the edge of the glass,

Pull the swinging door, **keeping the latch raised**.

To close the swinging door, push the door in the direction of the

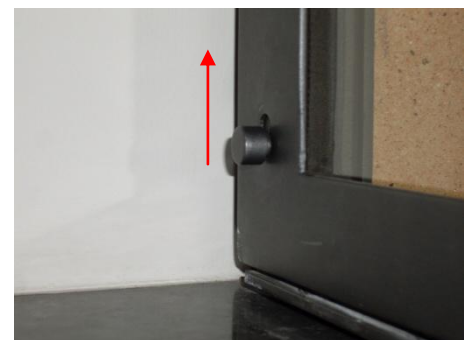

2.3 Combustion adjustment elements

Effective wood burning depends on the amount of air supplying the fire and the rate of smoke evacuation, i.e. the draught of the chimney.

When using the appliance with the door lowered (shut) for a completely safe, long-lasting fire, it is necessary to control the amount of air supply and the rate of smoke evacuation.

When using the appliance with the door open (door raised) smoke evacuation must be at the maximum rate as well as the amount of air available.

2.3.1 Smoke damper trap

Automatic smoke damper trap

Since 2011, recto-verso fireplaces have included an automatic smoke damper trap controlled by the foldaway door.

The damper trap opens when you raise the foldaway door (door open). This prevents down draughts of smoke; the trap closes when you lower the door (door closed).

In this way, the appliance automatically changes from operation with the door open, without smoke down draughts, to operation with the door shut, which optimizes heating and safety.

N.B.: Panoramic R°V° fireplaces are not concerned by this change and retain the control lever at the front (see page 11)

Presetting

This control allows you to preset opening of the damper trap, which controls evacuation of smoke, when the door is lowered.

The presetting control is located in the centre of the fireplace, above the door:

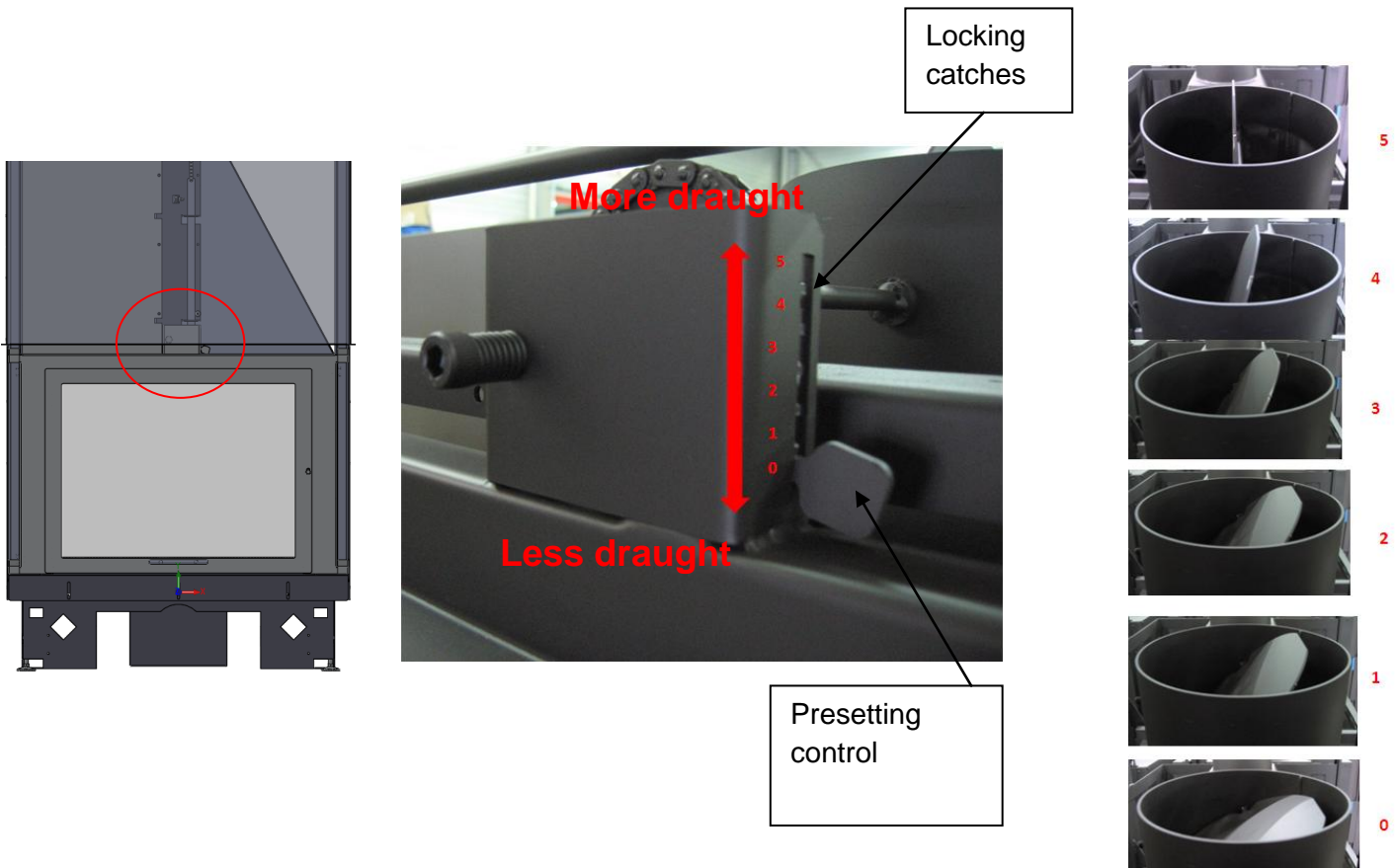

To change the setting:

- 1- Press the presetting control in order to disengage it from its catches
- 2- Keeping it pressed, make it slide up or down in order to obtain the desired setting:
 - Control at the top = trap more open → increased draught
 - Control at the bottom = trap more closed → decreased draught
- 3- Once you have obtained the desired position, release the control.
- 4- When using the appliance for the first few times, it will be necessary to set the damper trap according to the natural draught of your chimney.

2.3.2 Control lever for smoke damper trap

Concerns only Panoramic R°V° fireplaces.

The control lever for the smoke damper trap is a control device connected to the damper trap. It controls evacuation of smoke from the appliance.

The control lever was designed to be operated using the Totem safe handling tool.

This prevents the risk of burns whilst your fireplace is in use.

To increase smoke evacuation, push to the right

To reduce evacuation, push to the left

Recommendation: In order to prevent down draughts of smoke, increase smoke evacuation to the maximum before opening the door.



2.3.3 Combustion air

Combustion air is an essential element of the combustion of a fire; the following adjustment elements allow you to manage its rate.

Adjustable air grate 6

The ash tray's adjustable air grate has two functions: controlling the rate of the fire and deashing the fireplace.

For your comfort and safety, the Totem company has equipped the adjustable air grate so that you can handle it using the safe handling tool.

To increase the supply of combustion air and the rate of the fire, push the grate.

To reduce the supply of combustion air and the rate of the fire, pull the grate.

To deash the fireplace, manoeuvre the grate from front to back using the safe handling tool.

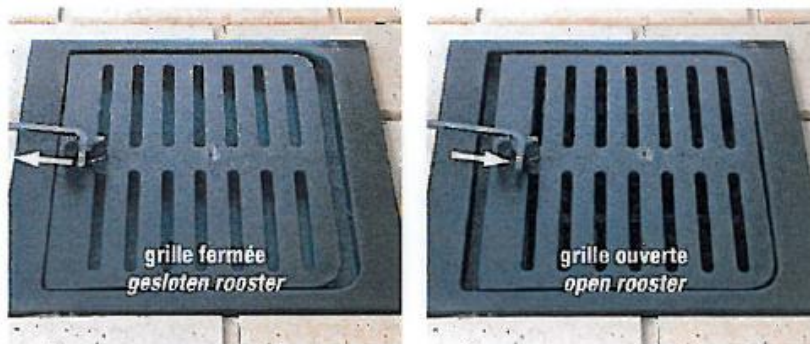

Combustion air intake flap

The combustion air intake flap is an optional extra which can be placed upstream of the adjustable air grate.

It allows you to control the incoming air flow rate. The Totem company strongly recommends that you install one.

It is used to close your appliance's air inlets when it is not in use.

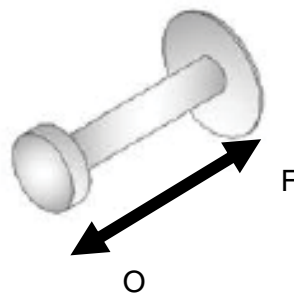

To increase the incoming air flow rate, pull the control lever.

To close or reduce the incoming air flow rate, push the lever.

2.3.4 Reflectors

The TOTEM FIRE company recommends that they are installed to improve efficiency.

The reflectors fitted on your fireplace reduce the temperature of the smoke evacuated and increase that of the fire. In this way, they directly contribute to improving the performance of your equipment. They are detachable for chimney sweeping.

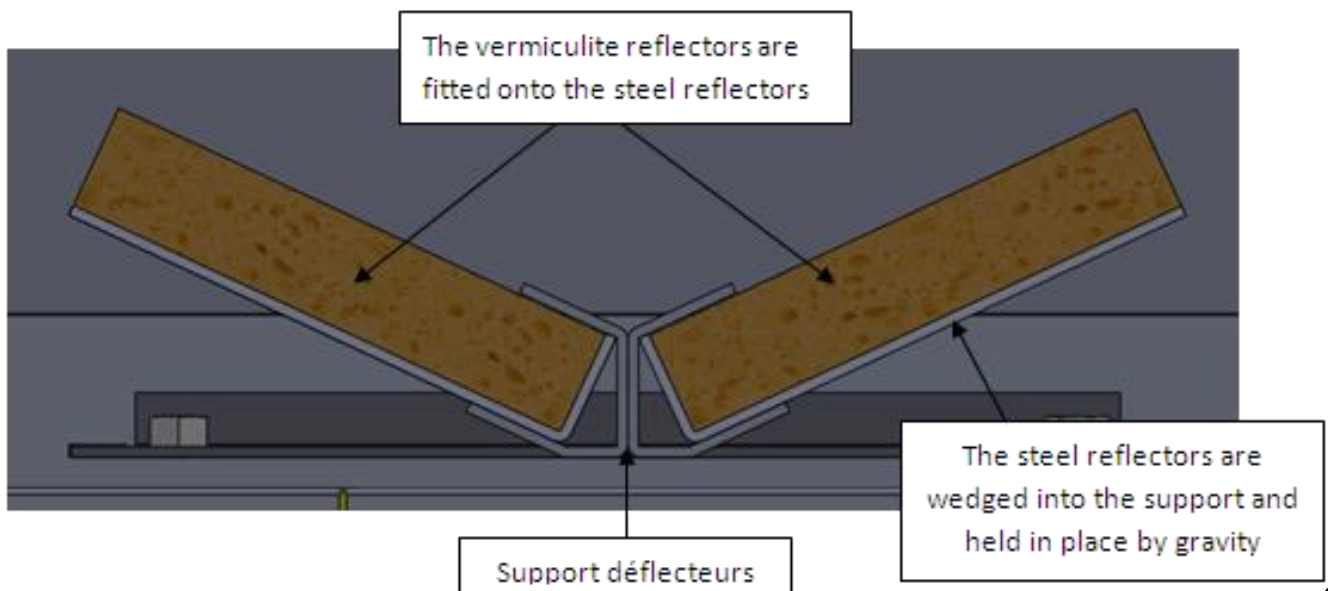
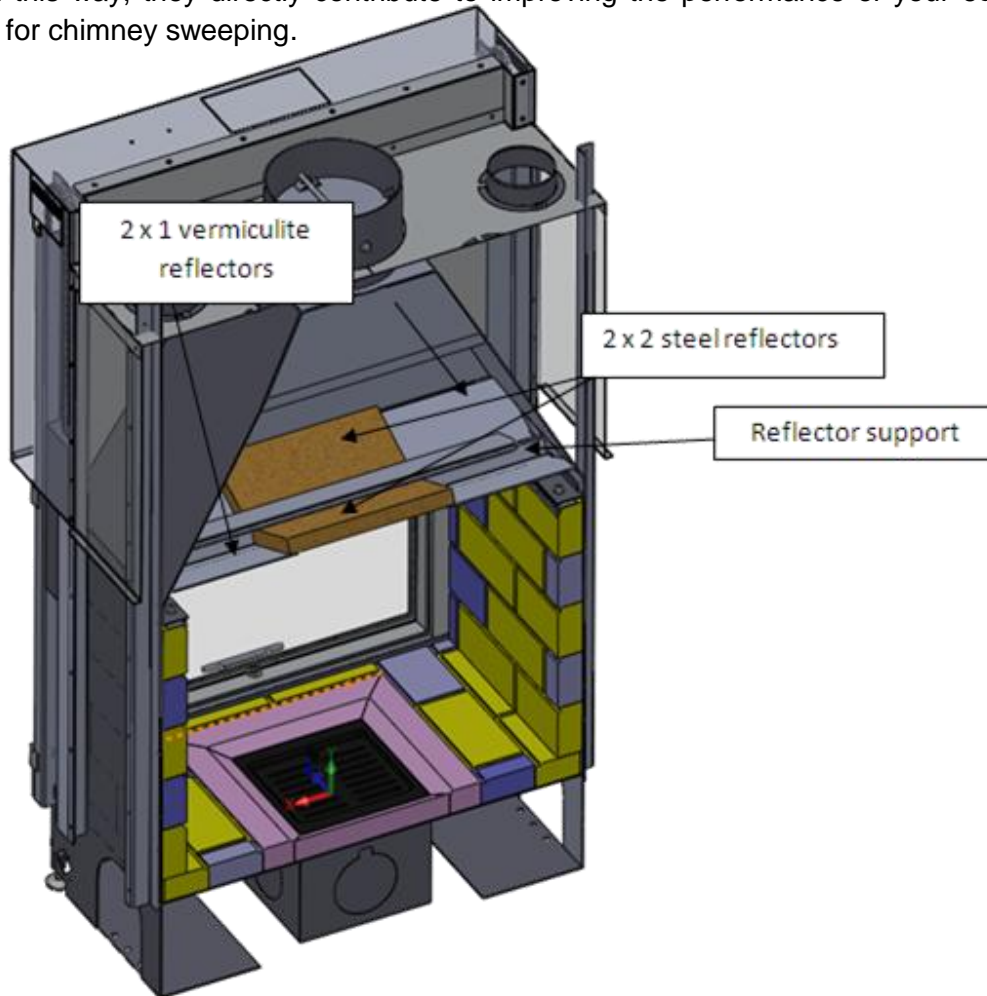

2.4 Using your appliance for the first time

Before lighting your fire for the first time, remove any documents and accessories it may contain. Also check the ash pit.

Allow covering materials to dry (rough plaster, finishing plaster...) before using the appliance for the first time to prevent them from deteriorating by drying too quickly.

During the first few hours of use, maintain a moderate fire to allow the materials time to cure.

Each time you use the fireplace, gradually increase the load of wood.

Smoke and odours may be released the first few times you use the fire.

They are due to final evaporation of paint, the sheet metal preservative oil and drying bricks. If this occurs, ensure that the room in which the appliance is located is well ventilated.

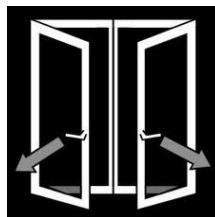

For your well-being and comfort, our technical teams are constantly working to improve our products; since May 2012, we have been using **solvent-free water soluble paint** to limit these fumes.

2.5 How to operate the fire

2.5.1 Lighting

If you have not used your appliance for a long time, check that none of your fireplace's air passages are obstructed (chimney flue, outside air delivery pipe, convection and ventilation grille) before lighting.

Also check that mechanical parts such as the door, counterweights, and adjusters operate freely.

If your house is fitted with controlled mechanical ventilation or a suction hood, we recommend that you reduce its flow rate or turn it off at least when lighting the appliance.

Controlled mechanical ventilation and suction hoods extract air in the house. They can reverse the natural draught of a fireplace.

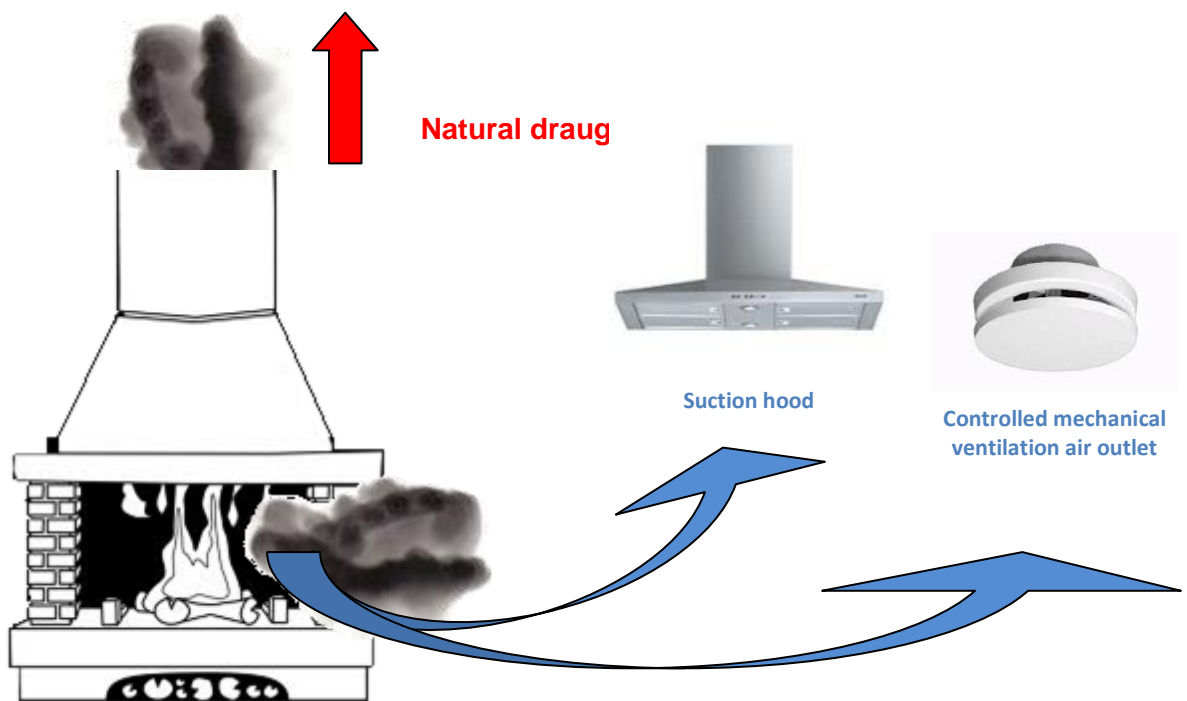

DOWN DRAUGHTS

For panoramic R°V° fireplaces, open the smoke damper trap using the lever on the front (see page 11)

- Open the main foldaway door (1)

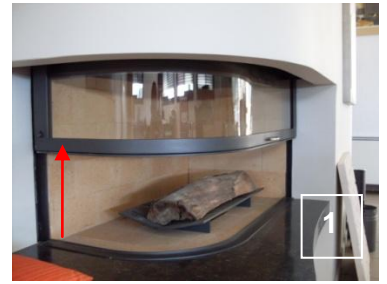

- Open the combustion air flap (2) and the adjustable grate of the ash tray (3).

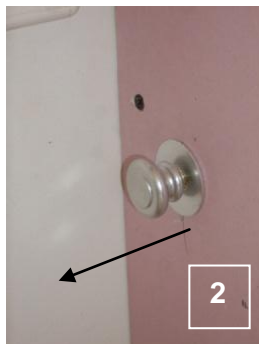

- 4
- Place two or three chopped logs in the centre of the fireplace.
 - Place dry and resawn kindling on top. Position your wood so as to allow air to circulate freely.
 - Place paper or firelighter on the kindling.



- Light the paper or firelighter

- Allow the flue to increase gradually in temperature without causing the fire to become over active.

Recommendation: Never overload your fireplace with wood, especially when starting it up.



2.5.2 Adding wood

To open the door during operation, slightly raise the door, pausing before fully opening it to prevent any risk of down draught.

Use protective gloves or the Totem safe handling tool to operate the fireplace's door handle in order to protect you from burns.

Maximum loads of dry wood per hour of operation

Maximum	Weight	50 cm logs	Equivalence in kW
800	3 kg	1 à 2	12
900	4 kg	2 à 3	18
1000 and +	5 kg	3	20



2 logs weighing approximately 3 kg



3 logs weighing approximately 4kg



4 logs weighing approximately 5 kg

2.5.3 Extinction

Fully lower the door (1).

For R°V° fireplaces, close the smoke damper trap.

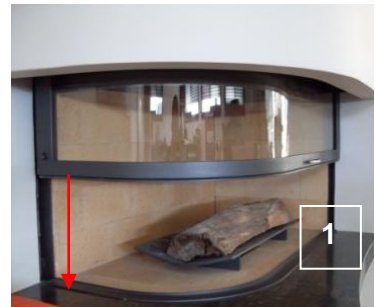

Close the adjustable grate of the ash tray (2) as well as the air intake flap (3).

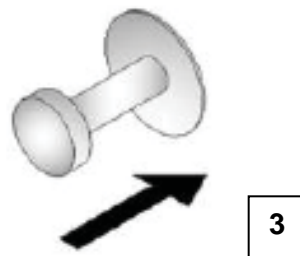

Allow the fire to go out.

2.6 Initial checks in case of poor functioning

- **When the door is closed**, the wood burns too quickly and the fire is over active:
 - Is the fire door shut properly?
 - Is the smoke damper trap jammed? (see page 9)
 - Are the reflectors in place? (see page 12)
 - Do you use recommended firewood? (see page 26)
 - Is the wood too small?
- **When the door is closed**, the fireplace does not heat up sufficiently:
 - Are the ventilation and convection grilles clogged up?
 - Is the fireplace door correctly shut?
 - Is the smoke damper trap obstructed? (see page 9)
 - Have you loaded enough wood?
- The wood does not burn well:
 - Is the wood too humid? (see page 28)
 - Are the pieces of wood too large? If so, saw them.
- **When the door is open**, the draught of the fireplace is too weak, there is too much down draught:
 - Is the smoke damper trap obstructed? (see page 9)
 - Are the combustion air flap (optional extra) and grille sufficiently open? (see page 11)
 - Is the flue clogged up or poorly insulated?
 - Does switching off the controlled mechanical ventilation facilitate the draught? (see page 14)
 - Does removing the reflector improve the draught? (See page 12); if need be, reduce its length.

2.7 Maintenance guide

Before carrying out any maintenance on your appliance, wait for it to completely cool down to prevent any risk of burns or fire.

2.7.1 Cleaning the glass

Carefully cover the floor below the door so as not to mark it.

Take a pair of gloves, a bucket of warm water, a sponge, washing up liquid or a product for cleaning glass and newspaper.

Never use abrasive oven products, this damages the door gaskets.

Open the swinging door (see page 7)

Apply the product on the inside of the glass and allow it time to act.

Do not spray the product directly onto the glass. Spray it onto a cloth then wipe the glass with the cloth.

During this time, empty the ash tray and clean the fireplace.

Use a wet cloth to rinse.

Dry with newspaper.

Repeat these cleaning procedures until the glass is clean.

Note: using good quality, sufficiently dry wood (see page 28) reduces carbon deposits on the glass.

2.7.2 Cleaning the fireplace

Removing ash

In order to prevent obstruction of the combustion air inlet grille, it is necessary to regularly empty the ash pit located under the cast iron grate.

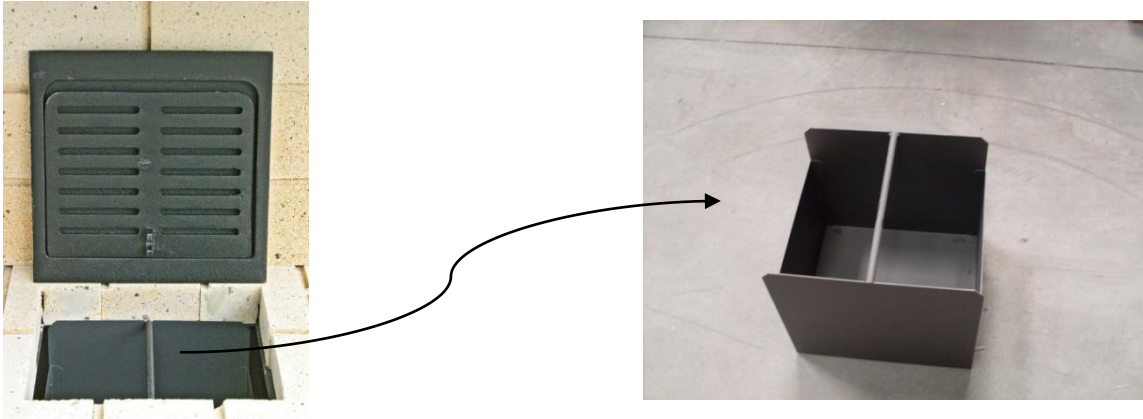

Collect the ash in a specially designed recipient (inflammable and fitted with a cover) - the presence of residual embers can cause a fire.

For safety reasons, it is preferable to store the ashes outside.

Use a soft, dry cloth to clean the metal parts of the fireplace.

Tip: Your ashes can be used as compost for your garden.

Cleaning the bricks

Clean with a brush then apply linseed oil.



Cleaning the cast iron grate

Use a wire brush then rub with household oil to make it shine.

2.7.3 Maintenance and Chimney Sweeping

Maintenance

The appliances must be checked at least once a year and repaired if necessary by a qualified professional.

The chimney connectors must always be maintained in good working order, their maintenance must be carried out at least once a year.

The fresh air ducts must always be maintained in good working order.



Clean the outside grille allowing fresh air intake (leaves, dust...) at the start of the heating season and check it periodically throughout the period of use.

Twice a year, vacuum any dust and soot which have collected in the slides on both sides of the door.

Lubricate the bearings of the door on each side with heat-resistant oil. To do so, completely lower the door and access the bearings via the inspection grille.

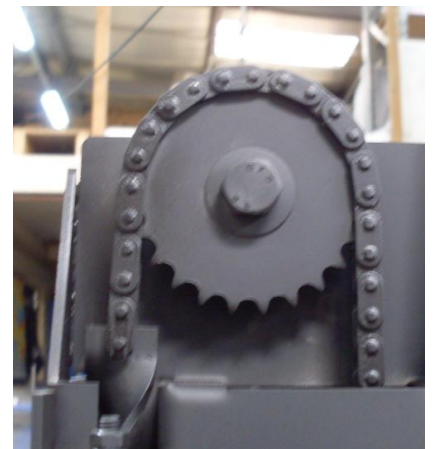

Clean the dust filters and grilles of the hood twice a year.



Clean the inside of the installation using a vacuum cleaner or brush in order to eliminate any dust deposits causing carbonization of dust (dirt around the hot air outlets and on the ceiling) at the start of the heating season and once during the heating season.



Check the condition of the door gaskets. Replace them if necessary.

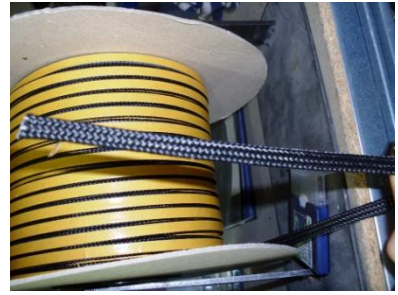

Spare parts

If you wish to replace parts, broken glass or worn gaskets, contact your fitter, providing the references for your fireplace.

Chimney sweeping

By chimney sweeping, we mean cleaning by direct mechanical action to the inside wall of the chimney flue in order to remove soot and deposits to prevent these from catching fire, ensuring that the flue is clear over its entire length.



Flue before chimney sweeping

Remove the reflectors from the appliance before chimney sweeping the flue (see page 12).

Chimney sweeping of the installation at least twice a year, including once during the heating season by a qualified professional company.

A certificate must be issued by the contractor after the work has been completed.



Flue after chimney sweeping

3 Basic information about firewood

Totem fireplaces are high-performance appliances. Using good fuel is essential for optimal functioning of your fireplace.

Wood is a renewable form of energy when it comes from sustainably managed forests.

In France, forests represent 30% of the country's area. French forests have been expanding for several centuries. (*Fibra*)

Here is some basic information about firewood.

3.1 General points

What is a stere of wood?

A stere of wood corresponds to 1m^3 of wooden logs measuring 1 m stacked parallel. However, since 1978, the legal sales unit is no longer the stere but the m^3 .

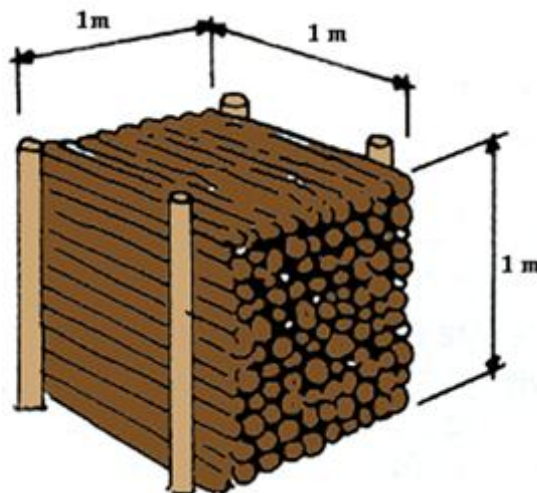

A stere is not always equivalent to one 1m^3 , the volume of the stere varies with the length of the logs. With smaller logs, the volume in m^3 will decrease but you still have the same amount of wood. The spaces are filled better.

Below, 3 steres of wood in logs measuring 33, 50 and 100cm.

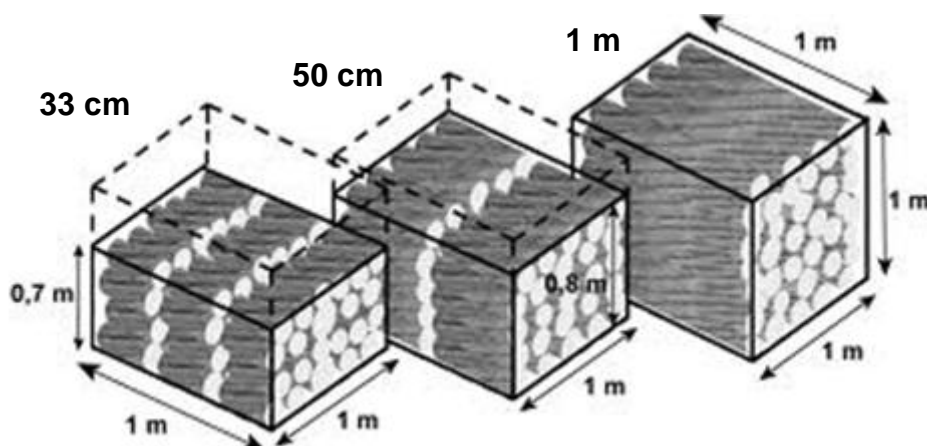

Which type of wood should I choose?

Birch: Birch burns quickly without its flames becoming too hot and leaves very little ash. It produces attractive, slightly bluish flames. It is a wood liked by bakers. It produces good embers and is used for lighting the fire.

Beech: Beech is excellent firewood: it dries quickly and offers good heating power. For drying, it must be placed under a shelter as soon as it has been resawn so that it does not rot. It is a wood which burns quickly, so it is easy to light. It emits pleasant odours when burning. It is considered the idea firewood. It produces attractive flames and good embers.

Oak: It burns very slowly. It has to be left for 1 year in the rain in order to remove all traces of tannin before being stored under shelter to dry. Oak produces the best embers. It burns slowly and produces a lot of heat.

Hornbeam: Hornbeam burns slowly which results in a good amount of heat production. Not much smoke is produced when burning. Hornbeam produces excellent embers which distribute heat over time. The flames that it produces are attractive and uniform.

Ash: Described as producing the most attractive flames, it is a wood which burns for a long time without projecting sparks and produces a large amount of heat. It is difficult to cut.

Chestnut: Chestnut is a strong wood. It used to be used for manufacturing barrels. It is mediocre firewood because it explodes and produces a lot of sparks when burning. When the fireplace door is lowered, it can be used without risk; when the door is raised we recommend that you use a fire screen.

Coniferous trees: Coniferous trees should not be used. This type of wood releases large amounts of heat but burns very quickly. When it burns it causes the projection of embers and the resins contained in the wood clog up the fireplaces and flues very quickly. These very large deposits of soot encourage fires to start in the flues.

Important:

- Oak and chestnut contain tannins which affect burning. They must be stored for 6 – 9 months in a non-sheltered area to remove the tannins before being stored in a sheltered area for a period of 2 years.
- Avoid burning too much bark as it creates 10% more ash.
- Also avoid using wood with knots in it as this reduces the appliance's performance
- Wood which is too dry is not good for burning. Indeed, the wood heats too quickly, does not burn for long enough and significantly increases the temperature of the smoke.
- Do not use wood gathered on beaches as it releases hydrogen chloride when burned.

There are 3 families of wood:

- hard hardwood (oak, beech, ash, chestnut, hornbeam, walnut...)
- soft hardwood (poplar, willow, alder, birch...)
- coniferous trees (pine, spruce, fir, larch, Douglas fir...)

We recommend that you use firewood from the hard hardwood family. It has better heating power for an equal volume. I.e., it has greater heating power for the same volume of wood burned.

Here is a table presenting the heating power, with equal humidity and volume, of the different species of wood.

The heating power is presented on the basis of beech wood (set arbitrarily at 100).

Species	Heating power
Recommended wood	
Hornbeam	110
Beech	100
Ash	97
False acacia	97
Oak	96
Elm	96

Species	Heating power
Wood to avoid	
Birch	93
Chestnut	89
Maple	84
Lime	76
Alder	71
Poplar	60



Hard
Soft
Coniferous

Species	eating power
Wood which must not be used	
Spruce	68
Fir	64
Larch	84
Pine	78

3.2 Drying of wood and its moisture content

For wood, we generally speak of the moisture content, represented by H%, known as moisture content on dry basis (in relation to oven dry wood).

Moisture content of wood:
$$H \% = \frac{\text{Mass of pure water}}{\text{Dry wood}} \times 100$$

Moisture content varies from 50 to 120% (or more) for saturated wood (green wood) and from 10 to 20% for air-dried wood

It is this value which is measured using our hygrometers.

It is important to note that wood which contains too much moisture does not produce heat and that the more moisture the wood contains the less warmth it will provide.

Indeed, the heat output produced by wood during burning is not used to warm you, it is used to evaporate the water that it contains.

Furthermore, humid wood increases carbon monoxide emissions by a factor of 2 to 4 compared with dry wood and encourages clogging of your appliance, in this way decreasing its efficiency.

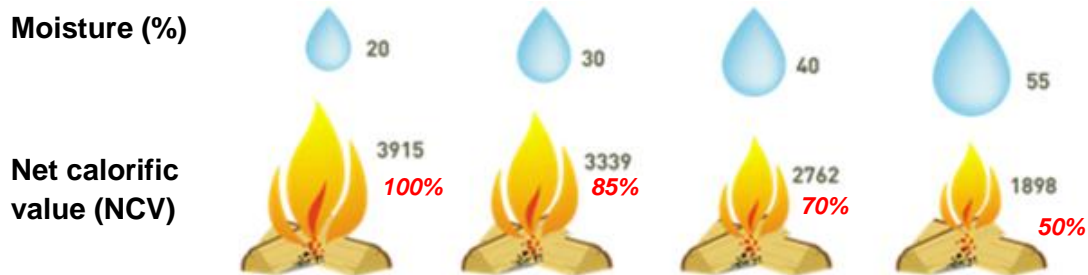

These figures correspond to the mean for hardwoods.

Covered



Well ventilated

Well aired

Furthermore, humid wood increases carbon monoxide emissions by a factor of 2 to 4 compared with dry wood and encourages clogging of your appliance, in this way decreasing its efficiency.

This is why wood must be dried for at least 15 – 18 months and stored in a sheltered, ventilated place, away from water and out of direct sunlight.

Wood must be resawn into logs, which encourages drying.

The duration may vary but in the end, you must obtain wood with moisture content always lower than 25%.

This content can be checked using our hygrometers which can be purchased from our distributors.

3.3 Types of fuel which are forbidden

- Plastic
- Liquids, solvents
- Household waste
- Hazardous or noxious waste
- Lignite
- Coal, petrol, alcohol...



Totem fireplaces are designed for domestic use. They should under no circumstances be used to incinerate waste of any kind.

It is forbidden to use treated wood which may produce toxic fumes and clog up the installation.

For your safety, you should also avoid intense fires. **Recycled wood (pallets, joinery wood, planks...) must not therefore be used** as it results in overheating which could damage the appliance, the chimney connector and the chimney flue.

4 Dimensions

RECTO/VERSO FIREPLACES													Glazing dimensions		
													old door	new door	
Overall dimensions a x b x c	Hearth h x i	Smoke vent j	weight in kg	Yield in %	Stated power in kW	Rate of CO (%)	Dimensions in mm			opening (m ²)					
							d	e	f		g				
THE SEPARATES															
R° FRONTAL 900 - V° BATTANT	1574 x 942 x 702	750 x 517	570	250	375	70%	14	0,27%	685	260	856	520	0,41		
R° FRONTAL 1000 - V° BATTANT	1644 x 1108 x 752	890 x 567	605	300	425	71%	20	0,06%	720	260	996	570	0,52		
R° HORIZON 901 - V° BATTANT	1241 x 968 x 578	750 x 390	405	200	250	71,4%	17,3	0,12%	518	260	856	396	0,29		
R° HORIZON 1000 - V° BATTANT	1241 x 1088 x 634	896 x 440	405	200	300	71%	20	0,06%	516	260	1002	452	0,35		
R° HORIZON 1100 - V° BATTANT	1454 x 1228 x 634	1010 x 440	510	250	450	78%	17	0,23%	624	260	1116	452	0,50		
R° HORIZON 1300 - V° BATTANT	1454 x 1312 x 634	1120 x 440	510	250	480	78%	17	0,23%	624	260	1226	452	0,555		
R° HORIZON 1400 - V° BATTANT	1454 x 1422 x 634	1230 x 440	510	250	510	73%	18	0,23%	624	260	1336	452	0,61		
R° VERTIVISION 900 - V° BATTANT	1860 x 790 x 697	598 x 512	994	250	410	74%	18	0,42%	686	120	704	515	0,29		
R° PANORAMIQUE 900 - V° FRONTAL BATTANT	1565 x 936 x 780	650 x 645	545	250	330	70%	16	0,29%	575	260	856	650	0,42		
THE CENTRAL															
R° - V° FRONTAL 900	1574 x 942 x 702	750 x 517	570	250	395	70%	14	0,27%	685	260	856	520	0,82		
R° - V° FRONTAL 1000	1644 x 1082 x 752	890 x 567	605	300	445	71%	20	0,06%	720	260	996	570	1,04		
R° - V° PANORAMIQUE 900	1575 x 820 x 936	614 x 756	545	250	350	70%	16	0,29%	585	260	820	842	0,96		

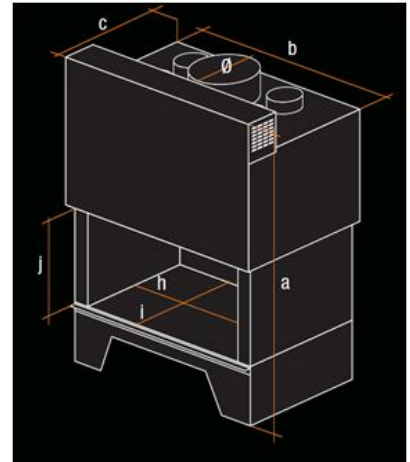

5 EC certifications

CERTIFICATION CE : NF EN 13 229 **RECTO/VERSO FIREPLACES**

	date	number	laboratory
SEPARATIFS			
R° FRONTAL 900 - V° BATTANT	18/10/2005	TD3930	CTIF
R° FRONTAL 1000 - V° BATTANT	18/03/2010	TD4201	CTIF
R° HORIZON 901 - V° BATTANT	29/07/2010	TD4226	CTIF
R° HORIZON 1000 - V° BATTANT	18/03/2010	TD4201	CTIF
R° HORIZON 1100 - V° BATTANT	04/11/2008	TD4088	CTIF
R° HORIZON 1300 - V° BATTANT	04/11/2008	TD4088	CTIF
R° HORIZON 1400 - V° BATTANT	28/03/2008	TD4045	CTIF
R° VERTIVISION 900 - V° BATTANT	19/11/2007	TD4034	CTIF
R° PANORAMIQUE 900 - V° FRONTAL BATTANT	12/02/2007	TD 3971	CTIF

CERTIFICATION CE : NF EN 13 229 **RECTO/VERSO FIREPLACES**

	date	number	laboratory
CENTRAUX			
R°- V° FRONTAL 900	18/10/2005	TD3930	CTIF
R° -V° FRONTAL 1000	18/03/2010	TD4201	CTIF
R° - V° PANORAMIQUE 900	12/02/2007	TD 3971	CTIF

6 Warranty

6.1 Statutory warranty

The statutory warranty, complete and compulsory, stems from application of articles 1641 et. seq. of the Civil Code.

If the buyer proves that there is a latent defect, the manufacturer must legally make good any foreseeable consequences.

6.2 Contract guarantee

The aim of the contract guarantee, which in no way excludes the statutory warranty, is to guarantee the buyer against any manufacturing faults or faulty material other than latent defects.

The guarantee is valid for 5 years from the purchase date indicated by the seller.

It includes, during this period, free exchange of faulty parts (parts and labour).

The appliance must be installed in such a way as to allow fast and easy disassembly and reassembly (inspection panel compulsory).

6.3 The following are not covered by the warranty

- damage caused by something external to the appliance (e.g. broken glass due to mechanical shock),
- damage resulting from forms of energy, use or installations which do not comply with the manufacturer's instructions and with legal and regulatory requirements,
- damage entailing the liability of a third party or resulting from a deliberate act or willful misconduct,
- wearing parts (brickwork, vitro-ceramics, vermiculite reflectors and combustion grilles).