

F117/F127

French quality active heat convector
with user-friendly controls



COMFORT

- Easy prog: 24h/7, program your device according to your life rhythm for greater comfort & savings (F127)
- Class II and IP 24 protection with dual electric insulation for ultimate safety
- Sheathed heating element with an aluminium diffuser (safe, silent and long-lasting)
- Automatic over heat safety device

SAVINGS

- High-precision electronic thermostat
- Up to 25% energy savings* (F127)
- ErP-ready**

USER-FRIENDLINESS

- Easy to install: H-shaped vertical support, which can also be used as an installation template

F127:

- Ergonomic LCD digital controls
- 2 modes: Manual/Prog





F117:

- Mode setting cursor and control knob
- 5-mode switch: Comfort, Eco, Frost-free, Off, Programme

DESIGN

- Front air outlet wings
- Colour: white (RAL 9016)



 <p>A B C</p> <p>Model available***</p>	<p>GENTLE HEAT RADIATOR 500 TO 2000 W</p> <p>Output</p>	 <p>Energy saving</p>
 <p>F127 F117</p> <p>Controls</p>	 <p>Technology</p>	 <p>Heating element type</p>

*Compared with a mechanical convector

**Depending on models

*** Model types: A: Horizontal / B: Vertical / C: Plinth

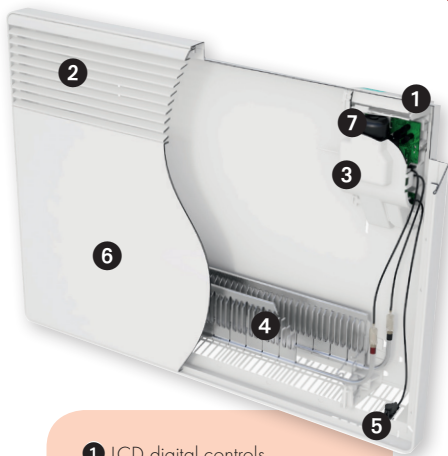

- 1 LCD digital controls
- 2 Air outlet
- 3 Over-heating safety device
- 4 Sheathed heating element with aluminium diffuser
- 5 Room temperature sensor
- 6 Front panel
- 7 Anti-tilt system

F117

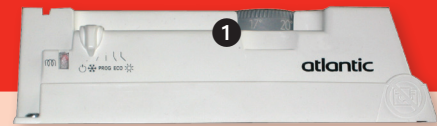

- 1 Temperature setting knob
- 2 Mode setting slider switch (Shutdown, Anti-frost, Programming, Comfort, Eco)
- 3 Heating light indicator

F127

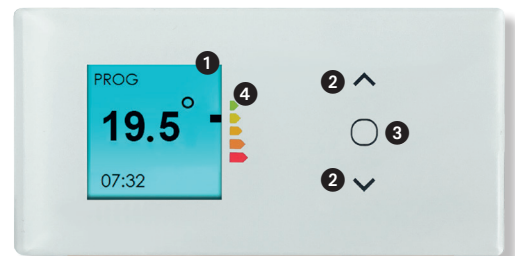

- 1 Temperature and active mode display - 2 modes: Manual/Prog
- 2 Navigation buttons
- 3 Access to menu/validation
- 4 Energy consumption indicator

INSTALLATION DIMENSIONS (in mm)

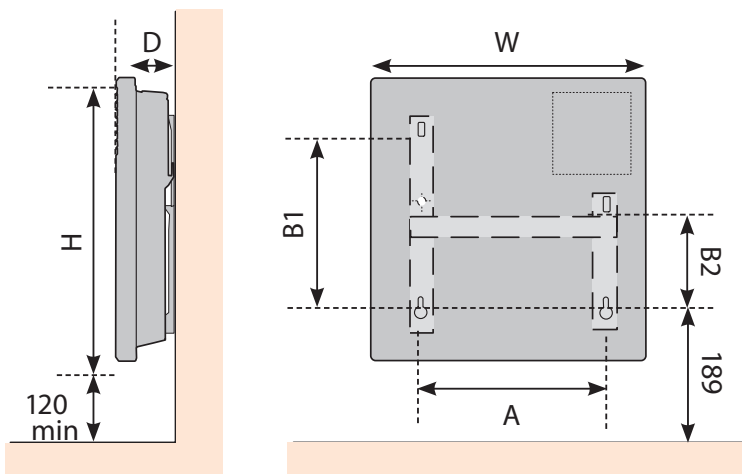

EASY PROG (for F127)

- **Manual mode:** allows to set-up the device at the desired temperature from OFF to 30°C.
- **Prog mode:** allows to set up to 3 periods of Comfort temperature by day (24h) over 7 days. Possibility to copy a daily programme on other days of the week.

F117/F127

TECHNICAL DATA

OUTPUT (W)	DIMENSIONS (mm)						NET WEIGHT (kg)
	Width (W)	Height (H)	Depth (D)	A	B1	B2	
500	370	453	103	195	256	158	3.8
1000	447	453	103	269	256	158	4.2
1500	590	453	103	343	256	158	5.5
2000	740	453	103	491	256	158	6.8